

AL ZAHRAWI SURGICAL

Surgical Instruments - Dental Instruments - Orthopedic Implants



Orthopedic Implants

CATALOG



AL ZAHRAWI SURGICAL
Surgical Instruments - Orthopedic Implants

Manufacturer & Supplier of
High Quality, Inventive, Low Cost

- ▶ Orthopedic Implants
- ▶ Veterinary Implants
- ▶ Orthopedic Surgical Instruments
- ▶ Orthopedic Surgical Instruments Set

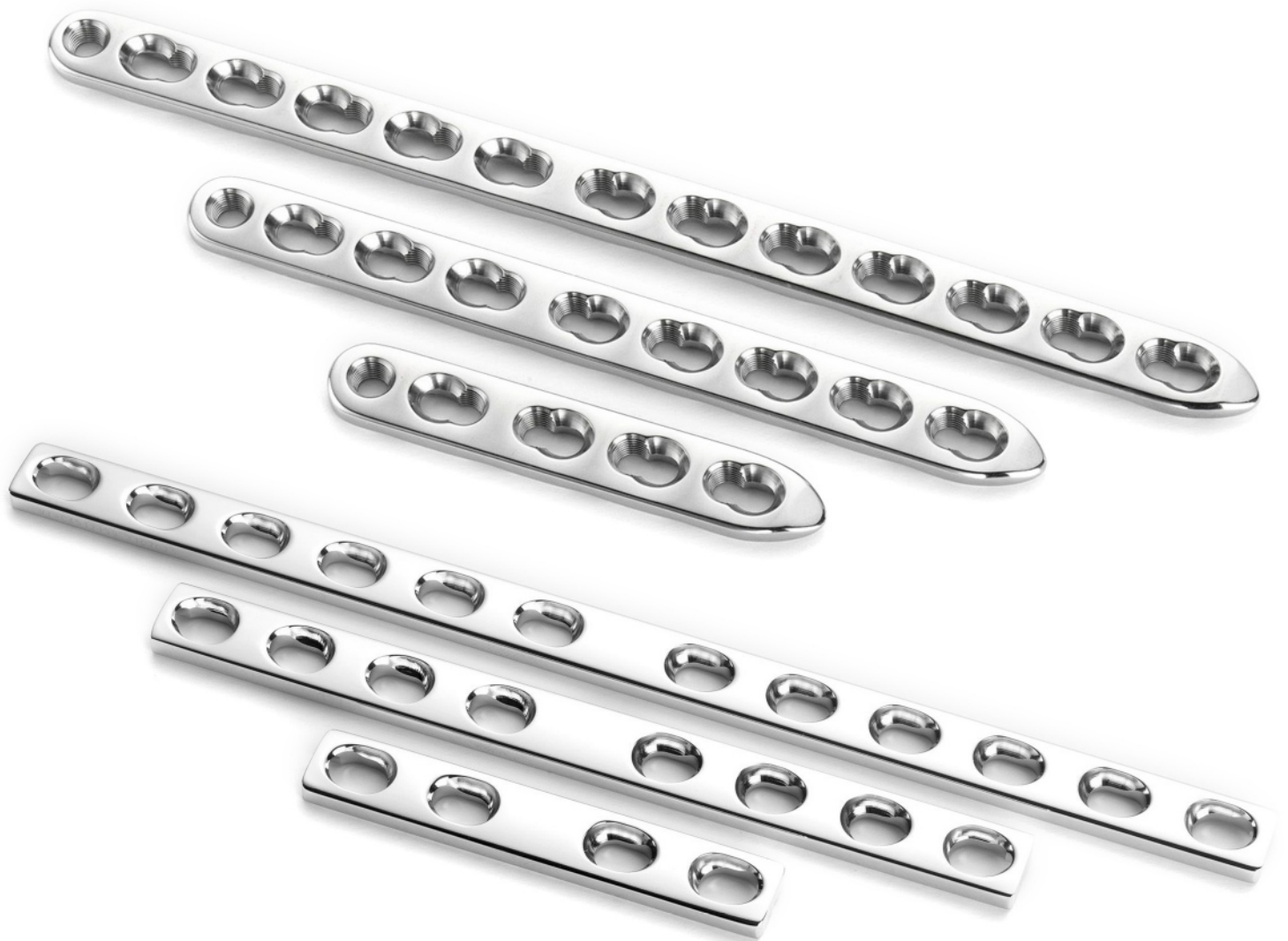

TABLE OF CONTENT

CHAPTER 1 (1.1 - 1.2)	—————	MINI FRAGMENT
CHAPTER 2 (2.1 - 2.3)	—————	2.4 MM LOCKING IMPLANTS
CHAPTER 3 (3.1 - 3.4)	—————	SMALL FRAGMENT
CHAPTER 4 (4.1 - 4.8)	—————	3.5 MM LOCKING IMPLANTS
CHAPTER 5 (5.1 - 5.5)	—————	LARGE FRAGMENT
CHAPTER 6 (6.1 - 6.5)	—————	5 MM LOCKING IMPLANTS
CHAPTER 7 (7.1 - 7.12)	—————	BONE SCREWS
CHAPTER 8 (8.1 - 8.4)	—————	PINS-STAPLES-WIRES
CHAPTER 9 (9.1 - 9.4)	—————	DHS-DCS AND ANGLED BLADE PLATE
CHAPTER 10 (10.1 - 10.9)	—————	INTERLOCKING NAILS
CHAPTER 11 (11.1 - 11.5)	—————	HIP PROSTHESIS
CHAPTER 12 (12.1 - 12.16)	—————	CRANIOMAXILLOFACIAL
CHAPTER 13 (13.1 - 13.3)	—————	SPINE PRODUCTS
CHAPTER 14 (14.1 - 14.20)	—————	EXTERNAL FIXATORS
CHAPTER 15 (15.1 - 15.3)	—————	HAND & FOOT

Chapter - 1 (Page 1.1 - 1.2)

MINI FRAGMENT

1.1 2.0mm Mini T-Plate



SS (code)	TI (code)
101001S	101001T

1.2 2.0mm Mini Straight Plate



Holes	SS (codes)	TI (codes)
2	102001S	102001T
3	102002S	102002T
4	102003S	102003T
5	102004S	102004T
6	102005S	102005T
7	102006S	102006T
8	102007S	102007T

1.3 2.0mm Mini L-Plate



Holes	SS (codes)	TI (codes)
Left	103001S	103001T
Right	103002S	103002T

1.4 2.0mm DCP Plate



Holes	SS (codes)	TI (codes)
4	104001S	104001T
5	104002S	104002T
6	104003S	104003T
7	104004S	104004T
8	104005S	104005T

1.5 2.7 mm Mini T-Plate



	SS (code)	TI (code)
Codes	105001S	105001T

1.7 2.7mm Mini L-Plate



Type	SS (codes)	TI (codes)
Left	107001LS	107001LT
Right	107002RS	107002RT

1.8 2.7mm DCP Plate



Holes	SS (codes)	TI (codes)
2	108001S	108001T
3	108002S	108002T
4	108003S	108003T
5	108004S	108004T
6	108005S	108005T
7	108006S	108006T
8	108007S	108007T
9	108008S	108008T
10	108009S	108009T
12	108010S	108010T

1.6 2.7mm Straight Reconstruction Plate



Holes	SS (codes)	TI (codes)
2	106001S	106001T
3	106002S	106002T
4	106003S	106003T
5	106004S	106004T
6	106005S	106005T
7	106006S	106006T
8	106007S	106007T
9	106008S	106008T
10	106009S	106009T
11	106010S	106010T
12	106011S	106011T
14	106012S	106012T
16	106013S	106013T
18	106014S	106014T
20	106015S	106015T
22	106016S	106016T
24	106017S	106017T

1.9 2.7mm One Quarter Tubular Plate



Holes	SS (codes)	TI (codes)
2	109001S	109001T
3	109002S	109002T
4	109003S	109003T
5	109004S	109004T
6	109005S	109005T
7	109006S	109006T
8	109007S	109007T
9	109008S	109008T
10	109009S	109009T

Chapter - 2 (Page 2.1 - 2.3)

2.4MM LOCKING IMPLANTS

Plate with 8 Head Holes



Holes	Type	TI (codes)
3	Left	201001TL
4	Left	201002TL
5	Left	201003TL
3	Right	201004TR
4	Right	201005TR
5	Right	201006TR

Radius Plate with 9 Head Holes



Holes	Type	TI (codes)
3	Left	202001TL
4	Left	202002TL
5	Left	202003TL
3	Right	202004TR
4	Right	202005TR
5	Right	202006TR

2.3 2.4/2.7mm Locking Volar Long Distal Radius



Holes	TI (codes)
8	203001T
10	203002T
12	203003T

2.4 2.4/2.7mm Locking Volar Distal Radius



Holes	Type	TI (codes)
3	Left	204001TL
3	Right	204002TR
5	Left	204003TL
5	Right	204004TR

2.5 2.4/2.7mm Locking Volar Extra-Articular Distal Radius Plate With 5 Head Holes



Holes	Type	TI (codes)
3	Left	205001TL
3	Right	205002TR
5	Left	205003TL
5	Right	205004TR

2.6 2.4/2.7mm Locking Volar Extra-Articular Distal Radius Plate With 4 Head Holes



Holes	Type	TI (codes)
3	Left	206001TL
3	Right	206002TR
5	Left	206003TL
5	Right	206004TR

2.7 2.4/2.7mm Locking Volar Juxta-Articular Distal Radius Plate with 5 Head Holes



Holes	Type	TI (codes)
3	Left	207001TL
3	Right	207002TR
5	Left	207003TL
5	Right	207004TR

2.8 2.4/2.7mm Locking Volar Distal Radius Buttress Plate With 5 Head Holes



Holes	Type	TI (codes)
3	Left	208001TL
3	Right	208001TR

2.9 2.4/2.7mm Locking Dorsal Distal Radius Straight Plate



Holes	TI (codes)
5	209001T
6	209002T

2.10 2.4/2.7mm Locking Dorsal Distal Radius T-Plate With 3 Head Holes



Shaft Holes	TI (codes)
3	210001T
4	210002T

2.11 2.4/2.7mm Locking Dorsal Distal Radius L-Plate With 2 Head Holes



Holes	Type	TI (codes)
3	Left	211001TL
3	Right	211002TR
4	Left	211003TL
4	Right	211004TR

2.12 2.4/2.7mm Locking Dorsal Distal Radius L-Plate With 3 Head Holes



Holes	Type	TI (codes)
3	Left	212001TL
3	Right	212002TR
4	Left	212003TL
4	Right	212004TR

2.13 2.4/2.7mm Locking Dorsal Distal Radius L-Plate Oblique



Holes	Type	TI (codes)
3	Left	213001TL
3	Right	213002TR
4	Left	213003TL
4	Right	213004TR

2.14 2.4/2.7mm Locking Proximal Radius Plate for Radial Head Rim



Holes	Type	TI (codes)
2	Left	214001TL
2	Right	214002TR
3	Left	214003TL
3	Right	214004TR
4	Left	214005TL
4	Right	214006TR

2.15 2.4/2.7mm Locking Proximal Radius Plate for Radial Head Neck



Holes	TI (codes)
2	215001T
3	215002T
4	215003T

Chapter - 3 (Page 3.1 - 3.4)

SMALL FRAGMENT

3.1 3.5mm Small T-Plate Right Angled With 3 Head Hole



Holes	SS (codes)	TI (codes)
3	301001S	301001T
4	301002S	301002T
5	301003S	301003T
6	301004S	301004T
7	301005S	301005T
8	301006S	301006T

3.2 3.5mm Small T-Plate Right Angled With 4 Head Hole



Holes	SS (codes)	TI (codes)
3	302001S	302001T
4	302002S	302002T
5	302003S	302003T
6	302004S	302004T
7	302005S	302005T
8	302006S	302006T

3.3 3.5mm Small T-Plate Oblique Angled

Holes	Left Direction		Right Direction	
	SS (codes)	TI (codes)	SS (codes)	TI (codes)
3	303001SL	303001TL	303001SR	303001TR
4	303002SL	303002TL	303002SR	303002TR
5	303003SL	303003TL	303003SR	303003TR
6	303004SL	303004TL	303004SR	303004TR
7	303005SL	303005TL	303005SR	303005TR
8	303006SL	303006TL	303006SR	303006TR



3.4 3.5mm Straight Reconstruction Plate



Holes	SS (codes)	TI (codes)
5	304001S	304001T
6	304002S	304002T
7	304003S	304003T
8	304004S	304004T
9	304005S	304005T
10	304006S	304006T
11	304007S	304007T
12	304008S	304008T
13	304009S	304009T
14	304010S	304010T
15	304011S	304011T
16	304012S	304012T
17	304013S	304013T
18	304014S	304014T
19	304015S	304015T
20	304016S	304016T
21	304017S	304017T
22	304018S	304018T

3.1



3.5 3.5mm Curved Reconstruction Plate



Holes	SS (codes)	TI (codes)
5	305001S	305001T
6	305002S	305002T
7	305003S	305003T
8	305004S	305004T
9	305005S	305005T
10	305006S	305006T
11	305007S	305007T
12	305008S	305008T
13	305009S	305009T
14	305010S	305010T
16	305011S	305011T
18	305012S	305012T

3.6 3.5mm Y-Reconstruction Plate



Holes	Size	SS (codes)	TI (codes)
6	Small	306001S	306001S
9	Medium	306002S	306002S
12	Large	306003S	306003S

3.7 3.5mm Hook Plate



Holes	SS (codes)	TI (codes)
4	307001S	307001T
5	307002S	307002T
6	307003S	307003T
7	307004S	307004T
8	307005S	307005T
10	307006S	307006T

3.8 3.5mm Clavicle Hook Plate



Holes	Hook Depth (mm)	Left Direction		Right Direction	
		SS (codes)	TI (codes)	SS (codes)	TI (codes)
4	12 mm	308001SL	308001TL	308001SR	308001TR
4	15 mm	308002SL	308002TL	308002SR	308002TR
4	18 mm	308003SL	308003TL	308003SR	308003TR
5	12 mm	308004SL	308004TL	308004SR	308004TR
5	15 mm	308005SL	308005TL	308005SR	308005TR
5	18 mm	308006SL	308006TL	308006SR	308006TR
6	12 mm	308007SL	308007TL	308007SR	308007TR
6	15 mm	308008SL	308008TL	308008SR	308008TR
6	18 mm	308009SL	308009TL	308009SR	308009TR
7	12 mm	308010SL	308010TL	308010SR	308010TR
7	15 mm	308011SL	308011TL	308011SR	308011TR
7	18 mm	308012SL	308012TL	308012SR	308012TR

3.2



3.9 3.5mm Small DCP Plate



Holes	SS (codes)	TI (codes)
2	309001S	309001T
3	309002S	309002T
4	309003S	309003T
5	309004S	309004T
6	309005S	309005T
7	309006S	309006T
8	309007S	309007T
9	309008S	309008T
10	309009S	309009T
11	309010S	309010T
12	309011S	309011T
13	309012S	309012T
14	309013S	309013T

3.10 3.5mm Small LC-DCP Plate



Holes	SS (codes)	TI (codes)
3	310001S	310001T
4	310002S	310002T
5	310003S	310003T
6	310004S	310004T
7	310005S	310005T
8	310006S	310006T
9	310007S	310007T
10	310008S	310008T
11	310009S	310009T
12	310010S	310010T
13	310011S	310011T
14	310012S	310012T

3.11 3.5mm Semi Tubular Plate



Holes	SS (codes)	TI (codes)
2	311001S	311001T
3	311002S	311002T
4	311003S	311003T
5	311004S	311004T
6	311005S	311005T
7	311006S	311006T
8	311007S	311007T
9	311008S	311008T
10	311009S	311009T
12	311010S	311010T

3.12 3.5mm Cloverleaf Plate



Holes	SS (codes)	TI (codes)
3	312001S	312001T
4	312002S	312002T
5	312003S	312003T
6	312004S	312004T
7	312005S	312005T
8	312006S	312006T
9	312007S	312007T
10	312008S	312008T
11	312009S	312009T
12	312010S	312010T
13	312011S	312011T
14	312012S	312012T

3.13 3.5mm One Third Tubular Plate



Holes	SS (codes)	TI (codes)
2	313001S	313001T
3	313002S	313002T
4	313003S	313003T
5	313004S	313004T
6	313005S	313005T
7	313006S	313006T
8	313007S	313007T
9	313008S	313008T
10	313009S	313009T
11	313010S	313010T
12	313011S	313011T

3.14 3.5mm One Third Tubular Plate with Collar



Holes	SS (codes)	TI (codes)
2	314001S	314001T
3	314002S	314002T
4	314003S	314003T
5	314004S	314004T
6	314005S	314005T
7	314006S	314006T
8	314007S	314007T
9	314008S	314008T
10	314009S	314009T
11	314010S	314010T
12	314011S	314011T

3.15 3.5mm Calcaneal Plate



Size (mm)	SS (codes)	TI (codes)
60	315001S	315001T
70	315002S	315002T

Chapter - 4 (Page 4.1 - 4.8)

3.5MM LOCKING IMPLANTS

4.1 3.5mm Locking Straight Reconstruction Plate



Holes	SS (codes)	TI (codes)
5	401001S	401001T
6	401002S	401002T
7	401003S	401003T
8	401004S	401004T
9	401005S	401005T
10	401006S	401006T
11	401007S	401007T
12	401008S	401008T
14	401009S	401009T
16	401010S	401010T
18	401011S	401011T
20	401012S	401012T
22	401013S	401013T

4.2 3.5mm Locking Curved Reconstruction Plate



Holes	SS (codes)	TI (codes)
4	402001S	402001T
5	402002S	402002T
6	402003S	402003T
7	402004S	402004T
8	402005S	402005T
9	402006S	402006T
10	402007S	402007T
11	402008S	402008T
12	402009S	402009T
13	402010S	402010T
14	402011S	402011T
15	402012S	402012T
16	402013S	402013T

4.3 3.5mm Locking Small DCP Plate Low Contact



Holes	SS (codes)	TI (codes)
5	403001S	403001T
6	403002S	403002T
7	403003S	403003T
8	403004S	403004T
9	403005S	403005T
10	403006S	403006T
11	403007S	403007T
12	403008S	403008T

4.4 3.5mm Locking One Third Tubular Plate



Holes	SS (codes)	TI (codes)
4	404001S	404001T
5	404002S	404002T
6	404003S	404003T
7	404004S	404004T
8	404005S	404005T
9	404006S	404006T
10	404007S	404007T
11	404008S	404008T
12	404009S	404009T

4.5 3.5mm Locking Low Profile Straight Reconstruction Plates



Holes	SS (codes)	TI (codes)
3	405001S	405001T
4	405002S	405002T
5	405003S	405003T
6	405004S	405004T
7	405005S	405005T
8	405006S	405006T
9	405007S	405007T
10	405008S	405008T
11	405009S	405009T
12	405010S	405010T
13	405011S	405011T
14	405012S	405012T
15	405013S	405013T
16	405014S	405014T
18	405015S	405015T
20	405016S	405016T

4.6 3.5mm Locking Low Profile Curved Reconstruction Plate



Holes	SS (codes)	TI (codes)
6	406001S	406001T
8	406002S	406002T
10	406003S	406003T
12	406004S	406004T
14	406005S	406005T
16	406006S	406006T

4.7 3.5mm Locking Low Profile Reconstruction J-Plate



Holes	SS (codes)	TI (codes)
10	407001S	407001T
12	407002S	407002T
14	407003S	407003T
16	407004S	407004T

4.8 3.5mm Locking Superior Anterior Clavicle Plate



Holes	Left Direction		Right Direction	
	SS (codes)	TI (codes)	SS (codes)	TI (codes)
6	408001SL	408001TL	408001SR	408001TR
7	408002SL	408002TL	408002SR	408002TR
8	408003SL	408003TL	408003SR	408003TR

4.9 3.5mm Locking Superior Anterior Clavicle Plate with Lateral Extension



Holes	Left Direction		Right Direction	
	SS (codes)	TI (codes)	SS (codes)	TI (codes)
3	409001SL	409001TL	409001SR	409001TR
4	409002SL	409002TL	409002SR	409002TR
5	409003SL	409003TL	409003SR	409003TR
6	409004SL	409004TL	409004SR	409004TR
7	409005SL	409005TL	409005SR	409005TR
8	409006SL	409006TL	409006SR	409006TR

4.10 3.5mm Locking Proximal Humerus Plate



Holes	SS (codes)	TI (codes)
5	410001S	410001T
6	410002S	410002T
7	410003S	410003T
8	410004S	410004T

4.11 PHILOS Proximal Humerus Plate



Holes	SS (codes)	TI (codes)
3	411001S	411001T
4	411002S	411002T
5	411003S	411003T

4.12 PHILOS Proximal Humerus Plate, Long



Holes	Length (mm)	SS (codes)	TI (codes)
3	106	412001S	412001T
4	124	412002S	412002T
5	142	412003S	412003T
6	160	412004S	412004T
7	178	412005S	412005T
8	196	412006S	412006T
9	214	412007S	412007T
10	232	412008S	412008T
11	250	412009S	412009T
12	268	412010S	412010T
13	286	412011S	412011T

4.13 3.5mm Locking Dorsolateral Distal Humerus Plates With Support



Holes	Left Direction		Right Direction	
	SS (codes)	TI (codes)	SS (codes)	TI (codes)
3	413001SL	413001TL	413001SR	413001TR
5	413002SL	413002TL	413002SR	413002TR
7	413003SL	413003TL	413003SR	413003TR
9	413004SL	413004TL	413004SR	413004TR
14	413005SL	413005TL	413005SR	413005TR

4.14 3.5mm Locking Dorsolateral Distal Humerus Plates



Holes	Left Direction		Right Direction	
	SS (codes)	TI (codes)	SS (codes)	TI (codes)
3	414001SL	414001TL	414001SR	414001TR
5	414002SL	414002TL	414002SR	414002TR
7	414003SL	414003TL	414003SR	414003TR
9	414004SL	414004TL	414004SR	414004TR
14	414005SL	414005TL	414005SR	414005TR

4.15 3.5mm Locking Medial Distal Humerus Plates



Holes	Left Direction		Right Direction	
	SS (codes)	TI (codes)	SS (codes)	TI (codes)
3	415001SL	415001TL	415001SR	415001TR
5	415002SL	415002TL	415002SR	415002TR
7	415003SL	415003TL	415003SR	415003TR
9	415004SL	415004TL	415004SR	415004TR
14	415005SL	415005TL	415005SR	415005TR

4.16 3.5mm Locking Extra-Articular Distal Humerus Plate



Holes	Left Direction		Right Direction	
	SS (codes)	TI (codes)	SS (codes)	TI (codes)
4	416001SL	416001TL	416001SR	416001TR
6	416002SL	416002TL	416002SR	416002TR
8	416003SL	416003TL	416003SR	416003TR
10	416004SL	416004TL	416004SR	416004TR
12	416005SL	416005TL	416005SR	416005TR
14	416006SL	416006TL	416006SR	416006TR

4.3



4.17 3.5mm Locking Medial Distal Tibia Plate



Holes	Left Direction		Right Direction	
	SS (codes)	TI (codes)	SS (codes)	TI (codes)
4	417001SL	417001TL	417001SR	417001TR
6	417002SL	417002TL	417002SR	417002TR
8	417003SL	417003TL	417003SR	417003TR
10	417004SL	417004TL	417004SR	417004TR
12	417005SL	417005TL	417005SR	417005TR
14	417006SL	417006TL	417006SR	417006TR

4.18 3.5mm Locking Medial Distal Tibia Plate Without Tab



Holes	Left Direction		Right Direction	
	SS (codes)	TI (codes)	SS (codes)	TI (codes)
4	418001SL	418001TL	418001SR	418001TR
6	418002SL	418002TL	418002SR	418002TR
8	418003SL	418003TL	418003SR	418003TR
10	418004SL	418004TL	418004SR	418004TR
12	418005SL	418005TL	418005SR	418005TR
14	418006SL	418006TL	418006SR	418006TR

4.19 3.5mm Locking Proximal Tibia Plate



Holes	Left Direction		Right Direction	
	SS (codes)	TI (codes)	SS (codes)	TI (codes)
4	419001SL	419001TL	419001SR	419001TR
6	419002SL	419002TL	419002SR	419002TR
8	419003SL	419003TL	419003SR	419003TR
10	419004SL	419004TL	419004SR	419004TR
12	419005SL	419005TL	419005SR	419005TR
14	419006SL	419006TL	419006SR	419006TR
16	419007SL	419007TL	419007SR	419007TR

4.20 3.5mm Locking Medial Proximal Tibial Plate



Holes	Left Direction		Right Direction	
	SS (codes)	TI (codes)	SS (codes)	TI (codes)
4	420001SL	420001TL	420001SR	420001TR
6	420002SL	420002TL	420002SR	420002TR
8	420003SL	420003TL	420003SR	420003TR
10	420004SL	420004TL	420004SR	420004TR
12	420005SL	420005TL	420005SR	420005TR
14	420006SL	420006TL	420006SR	420006TR
16	420007SL	420007TL	420007SR	420007TR
18	420008SL	420008TL	420008SR	420008TR
20	420009SL	420009TL	420009SR	420009TR

4.21 3.5mm Locking Posteromedial Proximal Tibia Plate



Holes	SS (codes)	TI (codes)
1	421001S	421001T
2	421002S	421002T
4	421003S	421003T
6	421004S	421004T
8	421005S	421005T
10	421006S	421006T

4.22 3.5mm Locking Metaphyseal Plate



Holes	SS (codes)	TI (codes)
6	422001S	422001T
7	422002S	422002T
8	422003S	422003T
9	422004S	422004T
10	422005S	422005T
11	422006S	422006T
12	422007S	422007T
14	422008S	422008T
16	422009S	422009T
18	422010S	422010T

4.24 3.5mm Locking Metaphyseal Plate for Medial Distal Tibia



Holes	SS (codes)	TI (codes)
3/5	423001S	423001T
4/5	423002S	423002T
5/5	423003S	423003T
6/5	423004S	423004T
7/5	423005S	423005T
8/5	423006S	423006T
9/5	423007S	423007T
11/5	423008S	423008T
13/5	423009S	423009T
15/5	423010S	423010T



Holes	Left Direction		Right Direction	
	SS (codes)	TI (codes)	SS (codes)	TI (codes)
4 + 4	424001SL	424001TL	424001SR	424001TR
4 + 5	424002SL	424002TL	424002SR	424002TR
4 + 6	424003SL	424003TL	424003SR	424003TR
4 + 7	424004SL	424004TL	424004SR	424004TR
4 + 8	424005SL	424005TL	424005SR	424005TR
4 + 9	424006SL	424006TL	424006SR	424006TR
4 + 10	424007SL	424007TL	424007SR	424007TR
4 + 12	424008SL	424008TL	424008SR	424008TR
4 + 14	424009SL	424009TL	424009SR	424009TR
4 + 16	424010SL	424010TL	424010SR	424010TR
4 + 18	424011SL	424011TL	424011SR	424011TR
4 + 20	424012SL	424012TL	424012SR	424012TR

4.25 3.5mm Locking Metaphyseal Plate for Distal Medial Humerus



Holes	SS (codes)	TI (codes)
7	425001S	425001T
9	425002S	425002T
11	425003S	425003T
13	425004S	425004T
15	425005S	425005T

4.26 3.5mm Locking Clavicle Plates



Holes	Left Direction		Right Direction	
	SS (codes)	TI (codes)	SS (codes)	TI (codes)
3	426001SL	426001TL	426001SR	426001TR
4	426002SL	426002TL	426002SR	426002TR
4 Medium	426003SL	426003TL	426003SR	426003TR
6 Small	426004SL	426004TL	426004SR	426004TR
6 Medium	426005SL	426005TL	426005SR	426005TR
6 Large	426006SL	426006TL	426006SR	426006TR
8 Medium	426007SL	426007TL	426007SR	426007TR

4.27 3.5mm Locking Calcaneal Plate



Direction	Length (mm)	SS (codes)	TI (codes)
Left	69	427001S	427001T
Left	76	427002S	427002T
Right	69	427003S	427003T
Right	76	427004S	427004T

4.28 3.5mm Locking Hook Plate



Holes	SS (code)	TI (code)
3	428001S	428001T

4.29 3.5mm Locking Clavicle Hook Plate

Holes	Hook Depth	Left Direction		Right Direction	
		SS (codes)	TI (codes)	SS (codes)	TI (codes)
4	12 mm	429001SL	429001TL	429001SR	429001TR
4	15 mm	429002SL	429002TL	429002SR	429002TR
4	18 mm	429003SL	429003TL	429003SR	429003TR
5	12 mm	429004SL	429004TL	429004SR	429004TR
5	15 mm	429005SL	429005TL	429005SR	429005TR
5	18 mm	429006SL	429006TL	429006SR	429006TR
6	12 mm	429007SL	429007TL	429007SR	429007TR
6	15 mm	429008SL	429008TL	429008SR	429008TR
6	18 mm	429009SL	429009TL	429009SR	429009TR
7	12 mm	429010SL	429010TL	429010SR	429010TR
7	15 mm	429011SL	429011TL	429011SR	429011TR
7	18 mm	429012SL	429012TL	429012SR	429012TR



4.30 3.5mm Locking Small T Plate with 3 Holes in Head



Holes	SS (codes)	TI (codes)
3	430001S	430001T
4	430002S	430002T
5	430003S	430003T
6	430004S	430004T

4.31 3.5mm Locking Small T Plate with 4 Holes in Head



Holes	SS (codes)	TI (codes)
3	431001S	431001T
4	431002S	431002T
5	431003S	431003T
6	431004S	431004T

4.32 3.5mm Locking Small T Plate Oblique Angled



Holes	Left Direction		Right Direction	
	SS (codes)	TI (codes)	SS (codes)	TI (codes)
3	432001SL	432001TL	432001SR	432001TR
4	432002SL	432002TL	432002SR	432002TR
5	432003SL	432003TL	432003SR	432003TR
6	432004SL	432004TL	432004SR	432004TR

4.33 3.5mm Locking Pilon Plate

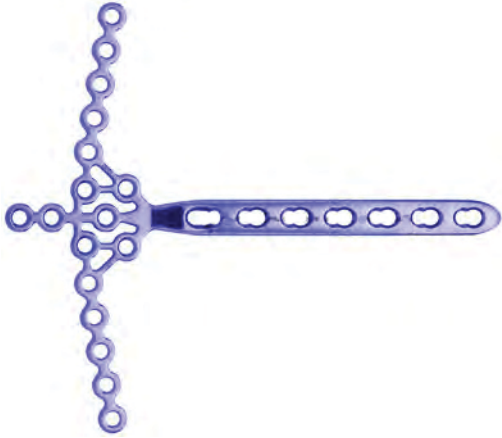

Holes	Length (mm)	SS (codes)	TI (codes)
7	147	433001S	433001T
9	173	433002S	433002T

4.34 3.5mm Locking Cloverleaf Plate



Holes	SS (codes)	TI (codes)
3	434001S	434001T
4	434002S	434002T
5	434003S	434003T
6	434004S	434004T

4.35 3.5mm Pubic Symphysis Plate 6 Holes Including 2 DCP Holes



Holes	SS (codes)	TI (codes)
4	435001S	435001T
6	435002S	435002T

4.36 3.5mm Locking Periarticular Proximal Humerus Plate



Holes	Left Direction		Right Direction	
	SS (codes)	TI (codes)	SS (codes)	TI (codes)
2	436001SL	436001TL	436001SR	436001TR
3	436002SL	436002TL	436002SR	436002TR
4	436003SL	436003TL	436003SR	436003TR
5	436004SL	436004TL	436004SR	436004TR
6	436005SL	436005TL	436005SR	436005TR
8	436006SL	436006TL	436006SR	436006TR
10	436007SL	436007TL	436007SR	436007TR
12	436008SL	436008TL	436008SR	436008TR
14	436009SL	436009TL	436009SR	436009TR

4.37 3.5mm Locking Paediatric Hip Plate



Holes	Length (mm)	Width (mm)	SS (codes)	TI (codes)
100°	75	18.5	437001S	437001T
110°	75	18.5	437002S	437002T
120°	75	18.5	437003S	437003T
150°	60	18.5	437004S	437004T

4.38 3.5mm Locking Olecranon Plate



Holes	Left Direction		Right Direction	
	SS (codes)	TI (codes)	SS (codes)	TI (codes)
2	438001SL	438001TL	438001SR	438001TR
4	438002SL	438002TL	438002SR	438002TR
6	438003SL	438003TL	438003SR	438003TR
8	438004SL	438004TL	438004SR	438004TR
10	438005SL	438005TL	438005SR	438005TR
12	438006SL	438006TL	438006SR	438006TR

4.39 2.7/3.5mm Locking Lateral Distal Fibula Plate



Holes	Left Direction		Right Direction	
	SS (codes)	TI (codes)	SS (codes)	TI (codes)
3	439001SL	439001TL	439001SR	439001TR
4	439002SL	439002TL	439002SR	439002TR
5	439003SL	439003TL	439003SR	439003TR
6	439004SL	439004TL	439004SR	439004TR
7	439005SL	439005TL	439005SR	439005TR

4.40 3.5mm Locking Anterolateral Distal Tibia Plate



Holes	Left Direction		Right Direction	
	SS (codes)	TI (codes)	SS (codes)	TI (codes)
5	440001SL	440001TL	440001SR	440001TR
7	440002SL	440002TL	440002SR	440002TR
9	440003SL	440003TL	440003SR	440003TR
11	440004SL	440004TL	440004SR	440004TR
13	440005SL	440005TL	440005SR	440005TR
15	440006SL	440006TL	440006SR	440006TR
17	440007SL	440007TL	440007SR	440007TR
19	440008SL	440008TL	440008SR	440008TR
21	440009SL	440009TL	440009SR	440009TR

4.41 3.5mm Locking Wrist Fusion Plate

Shape	Holes	SS (codes)	TI (codes)
Standard Bend	8	441001S	441001T
Short Bend	8	441002S	441002T
Straight Bend	9	441003S	441003T



Chapter - 5 (Page 5.1 - 5.5)

LARGE FRAGMENT

5.1 4.5mm Narrow Dynamic Compression Plate



Holes	SS (codes)	TI (codes)
4	501001S	501001T
5	501002S	501002T
6	501003S	501003T
7	501004S	501004T
8	501005S	501005T
9	501006S	501006T
10	501007S	501007T
11	501008S	501008T
12	501009S	501009T
13	501010S	501010T
14	501011S	501011T
15	501012S	501012T
16	501013S	501013T
17	501014S	501014T
18	501015S	501015T

5.2 4.5mm Broad Dynamic Compression Plate



Holes	SS (codes)	TI (codes)
4	502001S	502001T
5	502002S	502002T
6	502003S	502003T
7	502004S	502004T
8	502005S	502005T
9	502006S	502006T
10	502007S	502007T
11	502008S	502008T
12	502009S	502009T
13	502010S	502010T
14	502011S	502011T
15	502012S	502012T
16	502013S	502013T
17	502014S	502014T
18	502015S	502015T
19	502016S	502016T
20	502017S	502017T

5.3 4.5mm Narrow Limited Contact Dynamic Compression Plate



Holes	SS (codes)	TI (codes)
4	503001S	503001T
5	503002S	503002T
6	503003S	503003T
7	503004S	503004T
8	503005S	503005T
9	503006S	503006T
10	503007S	503007T
11	503008S	503008T
12	503009S	503009T
13	503010S	503010T
14	503011S	503011T
15	503012S	503012T
16	503013S	503013T
17	503014S	503014T
18	503015S	503015T

5.4 4.5mm Broad Limited Contact Dynamic Compression Plate



Holes	SS (codes)	TI (codes)
4	504001S	504001T
5	504002S	504002T
6	504003S	504003T
7	504004S	504004T
8	504005S	504005T
9	504006S	504006T
10	504007S	504007T
11	504008S	504008T
12	504009S	504009T
13	504010S	504010T
14	504011S	504011T
15	504012S	504012T
16	504013S	504013T
17	504014S	504014T
18	504015S	504015T
19	504016S	504016T
20	504017S	504017T

5.5 4.5mm T-Plate



Holes	SS (codes)	TI (codes)
3	505001S	505001T
4	505002S	505002T
5	505003S	505003T
6	505004S	505004T
7	505005S	505005T
8	505006S	505006T
9	505007S	505007T
10	505008S	505008T
11	505009S	505009T
12	505010S	505010T
13	505011S	505011T
14	505012S	505012T

5.6 4.5mm T-Buttress Plate



Holes	SS (codes)	TI (codes)
4	506001S	506001T
5	506002S	506002T
6	506003S	506003T
7	506004S	506004T
8	506005S	506005T
9	506006S	506006T
10	506007S	506007T
11	506008S	506008T
12	506009S	506009T
13	506010S	506010T
14	506011S	506011T

5.7 4.5mm L-Buttress Plate Right, Left Angled



Holes	SS (codes)	TI (codes)
3	507001S	507001T
4	507002S	507002T
5	507003S	507003T
6	507004S	507004T
7	507005S	507005T
8	507006S	507006T
9	507007S	507007T
10	507008S	507008T
11	507009S	507009T
12	507010S	507010T
13	507011S	507011T
14	507012S	507012T

5.8 4.5mm L-Buttress Plate Left, Right Angled



Holes	SS (codes)	TI (codes)
3	508001S	508001T
4	508002S	508002T
5	508003S	508003T
6	508004S	508004T
7	508005S	508005T
8	508006S	508006T
9	508007S	508007T
10	508008S	508008T
11	508009S	508009T
12	508010S	508010T
13	508011S	508011T
14	508012S	508012T

5.9 4.5mm Lateral Tibia Head Buttress Plate



Holes	Left Direction		Right Direction	
	SS (codes)	TI (codes)	SS (codes)	TI (codes)
5	509001SL	509001TL	509001SR	509001TR
7	509002SL	509002TL	509002SR	509002TR
9	509003SL	509003TL	509003SR	509003TR
11	509004SL	509004TL	509004SR	509004TR
13	509005SL	509005TL	509005SR	509005TR

5.10 4.5mm Lateral Tibia Head Buttress Plate LC-DCP



Holes	Left Direction		Right Direction	
	SS (codes)	TI (codes)	SS (codes)	TI (codes)
5	510001SL	510001TL	510001SR	510001TR
7	510002SL	510002TL	510002SR	510002TR
9	510003SL	510003TL	510003SR	510003TR
11	510004SL	510004TL	510004SR	510004TR
13	510005SL	510005TL	510005SR	510005TR

5.11 4.5mm Condylar Buttress Plate



Holes	Left Direction		Right Direction	
	SS (codes)	TI (codes)	SS (codes)	TI (codes)
7	511001SL	511001TL	511001SR	511001TR
9	511002SL	511002TL	511002SR	511002TR
11	511003SL	511003TL	511003SR	511003TR
12	511004SL	511004TL	511004SR	511004TR
13	511005SL	511005TL	511005SR	511005TR
15	511006SL	511006TL	511006SR	511006TR

5.12 4.5mm Condylar Buttress Plate LC Cuts



Holes	Left Direction		Right Direction	
	SS (codes)	TI (codes)	SS (codes)	TI (codes)
7	512001SL	512001TL	512001SR	512001TR
9	512002SL	512002TL	512002SR	512002TR
11	512003SL	512003TL	512003SR	512003TR
12	512004SL	512004TL	512004SR	512004TR
13	512005SL	512005TL	512005SR	512005TR
15	512006SL	512006TL	512006SR	512006TR

5.13 4.5mm Semi Tubular Plate



Holes	Left Direction		Right Direction	
	SS (codes)	TI (codes)	SS (codes)	TI (codes)
5	513002S	513002T		
6	513003S	513003T		
7	513004S	513004T		
8	513005S	513005T		
9	513006S	513006T		
10	513007S	513007T		
11	513008S	513008T		
12	513009S	513009T		

5.14 4.5mm Hook Plate



5.3



5.15 4.5mm Cobra Head Plate



Holes	SS (codes)	TI (codes)
9	515002S	515002T
10	515003S	515003T
11	515004S	515004T
12	515005S	515005T
13	515006S	515006T
14	515007S	515007T

5.16 4.5mm Spoon Plate



Holes	SS (codes)	TI (codes)
6	516002S	516002T

5.17 4.5mm Proximal Lateral Tibial Plate



Holes	SS (codes)	TI (codes)	SS (codes)	TI (codes)
3	517001SL	517001TL	517001SR	517001TR
5	517002SL	517002TL	517002SR	517002TR
7	517003SL	517003TL	517003SR	517003TR
9	517004SL	517004TL	517004SR	517004TR
11	517005SL	517005TL	517005SR	517005TR
13	517006SL	517006TL	517006SR	517006TR

5.18 4.5mm Fibular Distal Tibia Plate



Holes	SS (codes)	TI (codes)	SS (codes)	TI (codes)
7	518001SL	518001TL	518001SR	518001TR
9	518002SL	518002TL	518002SR	518002TR
11	518003SL	518003TL	518003SR	518003TR
13	518004SL	518004TL	518004SR	518004TR

5.19 4.5mm Distal Tibia Plate



Holes	SS (codes)	TI (codes)	SS (codes)	TI (codes)
3	519001SL	519001TL	519001SR	519001TR
5	519002SL	519002TL	519002SR	519002TR
7	519003SL	519003TL	519003SR	519003TR
9	519004SL	519004TL	519004SR	519004TR
11	519005SL	519005TL	519005SR	519005TR
13	519006SL	519006TL	519006SR	519006TR

5.20 4.5mm Straight Reconstruction Plate



Holes	SS (codes)	TI (codes)
4	520002S	520002T
5	520003S	520003T
6	520004S	520004T
7	520005S	520005T
8	520006S	520006T
9	520007S	520007T
10	520008S	520008T
11	520009S	520009T
12	520010S	520010T
13	520011S	520011T
14	520012S	520012T
15	520013S	520013T
16	520014S	520014T
17	520015S	520015T
18	520016S	520016T
20	520017S	520017T
22	520018S	520018T

5.21 4.5mm Distal Femur Plate



Holes	Direction			
	SS (codes)	TI (codes)	SS (codes)	TI (codes)
3	521001SL	521001TL	521001SR	521001TR
5	521002SL	521002TL	521002SR	521002TR
7	521003SL	521003TL	521003SR	521003TR
9	521004SL	521004TL	521004SR	521004TR
11	521005SL	521005TL	521005SR	521005TR
13	521006SL	521006TL	521006SR	521006TR

5.22 4.5mm Proximal Femur Plate



Holes	Left Direction		Right Direction	
	SS (codes)	TI (codes)	SS (codes)	TI (codes)
3	522001SL	522001TL	522001SR	522001TR
5	522002SL	522002TL	522002SR	522002TR
7	522003SL	522003TL	522003SR	522003TR
9	522004SL	522004TL	522004SR	522004TR
11	522005SL	522005TL	522005SR	522005TR
13	522006SL	522006TL	522006SR	522006TR

5.23 4.5mm Distal Lateral Tibia Plate



Holes	Direction			
	SS (codes)	TI (codes)	SS (codes)	TI (codes)
3	523001SL	523001TL	523001SR	523001TR
5	523002SL	523002TL	523002SR	523002TR
7	523003SL	523003TL	523003SR	523003TR
9	523004SL	523004TL	523004SR	523004TR
11	523005SL	523005TL	523005SR	523005TR
13	523006SL	523006TL	523006SR	523006TR

5.24 4.5mm Sherman Reconstruction Plate



Holes	Direction	
	SS (codes)	TI (codes)
4	524002S	524002T
5	524003S	524003T
6	524004S	524004T
7	524005S	524005T
8	524006S	524006T
9	524007S	524007T
10	524008S	524008T
11	524009S	524009T
12	524010S	524010T
13	524011S	524011T
14	524012S	524012T

5.25 4.5mm Proximal Medial Tibia Plate



Holes	Direction			
	SS (codes)	TI (codes)	SS (codes)	TI (codes)
3	525001SL	525001TL	525001SR	525001TR
5	525002SL	525002TL	525002SR	525002TR
7	525003SL	525003TL	525003SR	525003TR
9	525004SL	525004TL	525004SR	525004TR
11	525005SL	525005TL	525005SR	525005TR
13	525006SL	525006TL	525006SR	525006TR

Chapter - 6 (Page 6.1 - 6.5)

5.0MM LOCKING IMPLANTS

6.1 4.5/5.0mm Locking Proximal Lateral Tibial Plate



Holes	SS (codes)	TI (codes)	SS (codes)	TI (codes)
5	601001SL	601001TL	601001SR	601001TR
7	601002SL	601002TL	601002SR	601002TR
9	601003SL	601003TL	601003SR	601003TR
11	601004SL	601004TL	601004SR	601004TR
13	601005SL	601005TL	601005SR	601005TR

6.2 4.5/5.0mm Locking Proximal Femoral Plate



Holes	SS (codes)	TI (codes)	SS (codes)	TI (codes)
2	602001SL	602001TL	602001SR	602001TR
4	602002SL	602002TL	602002SR	602002TR
6	602003SL	602003TL	602003SR	602003TR
8	602004SL	602004TL	602004SR	602004TR
10	602005SL	602005TL	602005SR	602005TR
12	602006SL	602006TL	602006SR	602006TR
14	602007SL	602007TL	602007SR	602007TR
16	602008SL	602008TL	602008SR	602008TR

6.3 4.5/5.0mm Locking Proximal Tibia Plate



Holes	Left Direction		Right Direction	
	SS (codes)	TI (codes)	SS (codes)	TI (codes)
4	603001SL	603001TL	603001SR	603001TR
6	603002SL	603002TL	603002SR	603002TR
8	603003SL	603003TL	603003SR	603003TR
10	603004SL	603004TL	603004SR	603004TR
12	603005SL	603005TL	603005SR	603005TR
14	603006SL	603006TL	603006SR	603006TR

6.4 4.5/5.0mm Locking Proximal Femoral Hook Plate



2	604001S	604001T
4	604002S	604002T
6	604003S	604003T
8	604004S	604004T
10	604005S	604005T
12	604006S	604006T
14	604007S	604007T
16	604008S	604008T
18	604009S	604009T

6.5 4.5/5.0mm Locking Condylar Buttress Plate



4	605001SL	605001TL	605001SR	605001TR
5	605002SL	605002TL	605002SR	605002TR
6	605003SL	605003TL	605003SR	605003TR
7	605004SL	605004TL	605004SR	605004TR
8	605005SL	605005TL	605005SR	605005TR
9	605006SL	605006TL	605006SR	605006TR
10	605007SL	605007TL	605007SR	605007TR
11	605008SL	605008TL	605008SR	605008TR
12	605009SL	605009TL	605009SR	605009TR
13	605010SL	605010TL	605010SR	605010TR
14	605011SL	605011TL	605011SR	605011TR
15	605012SL	605012TL	605012SR	605012TR
16	605013SL	605013TL	605013SR	605013TR

6.6 4.5/5.0mm Locking Straight Reconstruction Plate



Holes	SS (codes)	TI (codes)
3	606001S	606001T
4	606002S	606002T
5	606003S	606003T
6	606004S	606004T
7	606005S	606005T
8	606006S	606006T
9	606007S	606007T
10	606008S	606008T
11	606009S	606009T
12	606010S	606010T
13	606011S	606011T
14	606012S	606012T
15	606013S	606013T
16	606014S	606014T

6.7 4.5/5.0mm Locking LC-DCP Broad Plate



5	607001S	607001T
6	607002S	607002T
7	607003S	607003T
8	607004S	607004T
9	607005S	607005T
10	607006S	607006T
11	607007S	607007T
12	607008S	607008T
13	607009S	607009T
14	607010S	607010T
15	607011S	607011T
16	607012S	607012T
18	607013S	607013T
20	607014S	607014T
22	607015S	607015T
24	607016S	607016T

6.8 4.5/5.0mm Locking LC-DCP Narrow Plate



2	608001S	608001T
3	608002S	608002T
4	608003S	608003T
5	608004S	608004T
6	608005S	608005T
7	608006S	608006T
8	608007S	608007T
9	608008S	608008T
10	608009S	608009T
11	608010S	608010T
12	608011S	608011T
14	608012S	608012T
16	608013S	608013T
18	608014S	608014T
20	608015S	608015T
22	608016S	608016T
24	608017S	608017T

6.9 4.5/5.0mm Locking Curved Broad Plate



12	609001S	609001T
13	609002S	609002T
14	609003S	609003T
15	609004S	609004T
16	609005S	609005T
17	609006S	609006T
18	609007S	609007T

6.10 4.5/5.0mm Locking L Buttress Plate



			Right Leg	
			(codes)	TL (codes)
3	610001SL	610001TL	610001SR	610001TR
4	610002SL	610002TL	610002SR	610002TR
5	610003SL	610003TL	610003SR	610003TR
6	610004SL	610004TL	610004SR	610004TR
7	610005SL	610005TL	610005SR	610005TR
8	610006SL	610006TL	610006SR	610006TR
9	610007SL	610007TL	610007SR	610007TR
10	610008SL	610008TL	610008SR	610008TR

6.11 4.5/5.0mm Locking T-Plate



4	611002S	611002T
5	611003S	611003T
6	611004S	611004T
7	611005S	611005T
8	611006S	611006T
9	611007S	611007T
10	611008S	611008T
12	611009S	611009T

6.12 4.5/5.0mm Locking T Buttress Plate



			(codes)
			2001T
5	612002S		612002T
6	612003S		612003T
7	612004S		612004T
8	612005S		612005T
9	612006S		612006T
10	612007S		612007T
12	612008S		612008T

6.13 4.5/5.0mm Locking Trochanter Stabilizing Plate for DHS

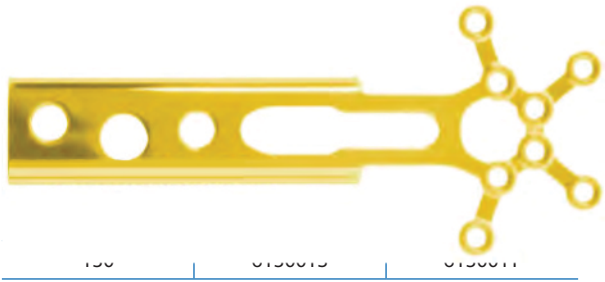

6.14 4.5/5.0mm Locking Medial High Tibia Plate Osteotomy



Holes	SS (code)	TI (code)
5	614001S	614001T

6.15 4.5/5.0mm Locking Medial Distal Femur Plate Osteotomy



Holes	SS (codes)	TI (codes)	SS (codes)	TI (codes)
4	615001SL	615001TL	615001SR	615001TR

6.16 4.5/5.0mm Locking Lateral High Tibia Plate Osteotomy



Right Leg				
Holes	SS (codes)	TI (codes)	SS (codes)	TI (codes)
3	616001SL	616001TL	616001SR	616001TR

6.17 4.5/5.0mm Locking Lateral Distal Femur Plate Osteotomy



Left Leg		Right Leg		
Holes	SS (code)	TI (code)	SS (code)	TI (code)
5	617001SL	617001TL	617001SR	617001TR

6.18 4.5/5.0mm Locking Distal Femur Plate



Holes	Left Direction		Right Direction	
	SS (codes)	TI (codes)	SS (codes)	TI (codes)
5	618001SL	618001TL	618001SR	618001TR
7	618002SL	618002TL	618002SR	618002TR
9	618003SL	618003TL	618003SR	618003TR
11	618004SL	618004TL	618004SR	618004TR
13	618005SL	618005TL	618005SR	618005TR

6.19 4.5/5.0mm Locking Medial Proximal Tibia Plate



Holes	Left Direction		Right Direction	
	SS (codes)	TI (codes)	SS (codes)	TI (codes)
4	619001SL	619001TL	619001SR	619001TR
6	619002SL	619002TL	619002SR	619002TR
8	619003SL	619003TL	619003SR	619003TR
10	619004SL	619004TL	619004SR	619004TR
12	619005SL	619005TL	619005SR	619005TR
14	619006SL	619006TL	619006SR	619006TR
16	619007SL	619007TL	619007SR	619007TR

6.20 4.5/5.0mm Locking Condylar Femoral Plates



Holes	Left Direction		Right Direction	
	SS (codes)	TI (codes)	SS (codes)	TI (codes)
7	620001SL	620001TL	620001SR	620001TR
9	620002SL	620002TL	620002SR	620002TR
11	620003SL	620003TL	620003SR	620003TR
12	620004SL	620004TL	620004SR	620004TR
13	620005SL	620005TL	620005SR	620005TR
15	620006SL	620006TL	620006SR	620006TR

6.21 5.0mm Locking Paediatric Hip Plate



Angle	Length (mm)	Width (mm)	SS (codes)	TI (codes)
100°	90	22.5	621001S	621001T
110°	90	22.5	621002S	621002T
120°	95	22.5	621003S	621003T
150°	75	22.5	621004S	621004T

6.22 Locking DHS Plate



SS (codes)						
Holes	38mm Barrel					Short Barrel (25mm)
	130°	135°	140°	145°	150°	135°
2	622001S	622016S	622031S	622046S	622061S	622076S
3	622002S	622017S	622032S	622047S	622062S	622077S
4	622003S	622018S	622033S	622048S	622063S	622078S
5	622004S	622019S	622034S	622049S	622064S	622079S
6	622005S	622020S	622035S	622050S	622065S	622080S
7	622006S	622021S	622036S	622051S	622066S	622081S
8	622007S	622022S	622037S	622052S	622067S	622082S
9	622008S	622023S	622038S	622053S	622068S	622083S
10	622009S	622024S	622039S	622054S	622069S	622084S
12	622010S	622025S	622040S	622055S	622070S	622085S
14	622011S	622026S	622041S	622056S	622071S	622086S
16	622012S	622027S	622042S	622057S	622072S	622087S
18	622013S	622028S	622043S	622058S	622073S	622088S
20	622014S	622029S	622044S	622059S	622074S	622089S
22	622015S	622030S	622045S	622060S	622075S	622090S

TI (codes)						
Holes	38mm Barrel					Short Barrel (25mm)
	130°	135°	140°	145°	150°	135°
2	622001T	622016T	622031T	622046T	622061T	622076T
3	622002T	622017T	622032T	622047T	622062T	622077T
4	622003T	622018T	622033T	622048T	622063T	622078T
5	622004T	622019T	622034T	622049T	622064T	622079T
6	622005T	622020T	622035T	622050T	622065T	622080T
7	622006T	622021T	622036T	622051T	622066T	622081T
8	622007T	622022T	622037T	622052T	622067T	622082T
9	622008T	622023T	622038T	622053T	622068T	622083T
10	622009T	622024T	622039T	622054T	622069T	622084T
12	622010T	622025T	622040T	622055T	622070T	622085T
14	622011T	622026T	622041T	622056T	622071T	622086T
16	622012T	622027T	622042T	622057T	622072T	622087T
18	622013T	622028T	622043T	622058T	622073T	622088T
20	622014T	622029T	622044T	622059T	622074T	622089T
22	622015T	622030T	622045T	622060T	622075T	622090T

6.23 Locking DCS Plate 95 Degree

Holes	SS (codes)	TI (codes)
6	623001S	623001T
7	623002S	623002T
8	623003S	623003T
9	623004S	623004T
10	623005S	623005T
12	623006S	623006T
14	623007S	623007T
16	623008S	623008T
18	623009S	623009T
20	623010S	623010T
22	623011S	623011T



Chapter - 7 (Page 7.1 - 7.12)

BONE SCREWS

2 mm Locking Cortical Screws

Length (mm): 8 mm - 30 mm

2.4 mm Locking Cortical Screws

Length (mm): 8 mm - 60 mm

2.7 mm Locking Cortical Screws

Length (mm): 8 mm - 60 mm

3.5 mm Locking Cortical Screws

Length (mm): 10 mm - 80 mm

5 mm Locking Cortical Screws

Length (mm): 10 mm - 120 mm

available in **SS316L & Titanium**



2 mm Cortical Screws

Length (mm): 8 mm - 30 mm

2.4 mm Cortical Screws

Length (mm): 8 mm - 60 mm

2.7 mm Cortical Screws

Length (mm): 8 mm - 60 mm

3.5 mm Cortical Screws

Length (mm): 10 mm - 80 mm

4.5 mm Cortical Screws

Length (mm): 10 mm - 120 mm

available in **SS316L & Titanium**



3.5 mm Locking Cancellous Screw

Length (mm): 10 mm - 80 mm

4 mm Locking Cancellous Screw

Length (mm): 10 mm - 80 mm

5 mm Locking Cancellous Screw

Length (mm): 20 mm - 120 mm

6.5 mm Locking Cancellous Screw

Length (mm): 25 mm - 130 mm

available in **SS316L & Titanium**

Screw Size	Thread Size
3.5 / 4 mm	Fully Thread
5 / 6.5 mm	16 mm Thread 32 mm Thread Fully Thread



3.5 mm Cancellous Screw

Length (mm): 10 mm - 80 mm

4 mm Cancellous Screw

Length (mm): 10 mm - 80 mm

6.5 mm Cancellous Screw

Length (mm): 25 mm - 130 mm

available in **SS316L & Titanium**

Screw Size	Thread Size
3.5 / 4 mm	Fully Thread
6.5 mm	16 mm Thread 32 mm Thread Fully Thread



4 mm Locking Cannulated Cancellous Screws

Length (mm): 10 mm - 80 mm

5 mm Locking Cannulated Cancellous Screws

Length (mm): 20 mm - 120 mm

6.5 mm Locking Cannulated Cancellous Screws

Length (mm): 25 mm - 130 mm

7.3 mm Locking Cannulated Cancellous Screws

Length (mm): 30 mm - 130 mm

available in **SS316L & Titanium**

Screw Size	Thread Type	Thread Size
4 / 5 mm	Cancellous	Fully Thread
6.5 / 7.3 mm	Cancellous	16 mm Thread 32 mm Thread Fully Thread



3.5 mm Cannulated Cortical Screws

Length (mm): 10 mm - 80 mm

4 mm Cannulated Cancellous Screws

Length (mm): 10 mm - 80 mm

4.5 mm Cannulated Cortical Screws

Length (mm): 20 mm - 120 mm

6.5 mm Cannulated Cancellous Screws

Length (mm): 25 mm - 130 mm

7 mm Cannulated Cancellous Screws

Length (mm): 30 mm - 130 mm

7.3 mm Cannulated Cancellous Screws

Length (mm): 30 mm - 130 mm

available in **SS316L & Titanium**



Screw Size	Thread Type	Thread Size
3.5 / 4.5 mm	Cortical	Partially Thread Fully Thread
4 mm	Cancellous	Partially Thread Fully Thread
6.5 / 7 / 7.3 mm	Cancellous	16 mm Thread 32 mm Thread Fully Thread



2.5 mm Headless Compression Screws Full Thread

Length (mm): 8 mm - 30 mm

3 mm Headless Compression Screws Full Thread

Length (mm): 8 mm - 40 mm

3.5 mm Headless Compression Screws Full Thread

Length (mm): 12 mm - 60 mm

4 mm Headless Compression Screws Full Thread

Length (mm): 12 mm - 60 mm

4.5 mm Headless Compression Screws Full Thread

Length (mm): 18 mm - 80 mm

5.5 mm Headless Compression Screws Full Thread

Length (mm): 20 mm - 80 mm

6.5 mm Headless Compression Screws Full Thread

Length (mm): 25 mm - 120 mm

available in **SS316L & Titanium**

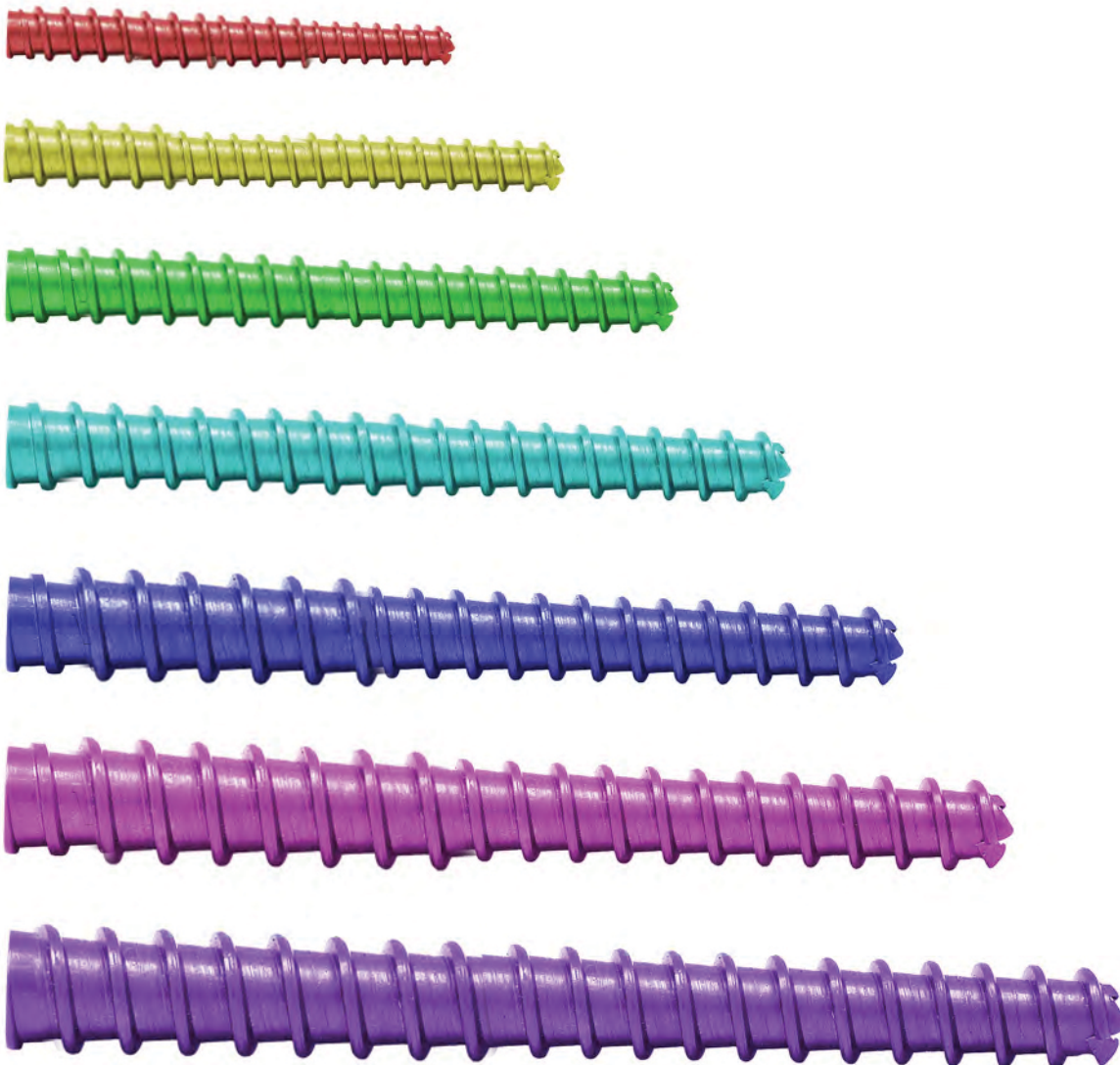

2.5 mm Headless Compression Screws Partially Thread

Length (mm): 8 mm - 30 mm

3 mm Headless Compression Screws Partially Thread

Length (mm): 8 mm - 40 mm

3.5 mm Headless Compression Screws Partially Thread

Length (mm): 12 mm - 60 mm

4 mm Headless Compression Screws Partially Thread

Length (mm): 12 mm - 60 mm

4.5 mm Headless Compression Screws Partially Thread

Length (mm): 18 mm - 80 mm

5.5 mm Headless Compression Screws Partially Thread

Length (mm): 20 mm - 120 mm

6.5 mm Headless Compression Screws Partially Thread

Length (mm): 25 mm - 120 mm

7.5 mm Headless Compression Screws Partially Thread

Length (mm): 25 mm - 120 mm

available in **SS316L & Titanium**

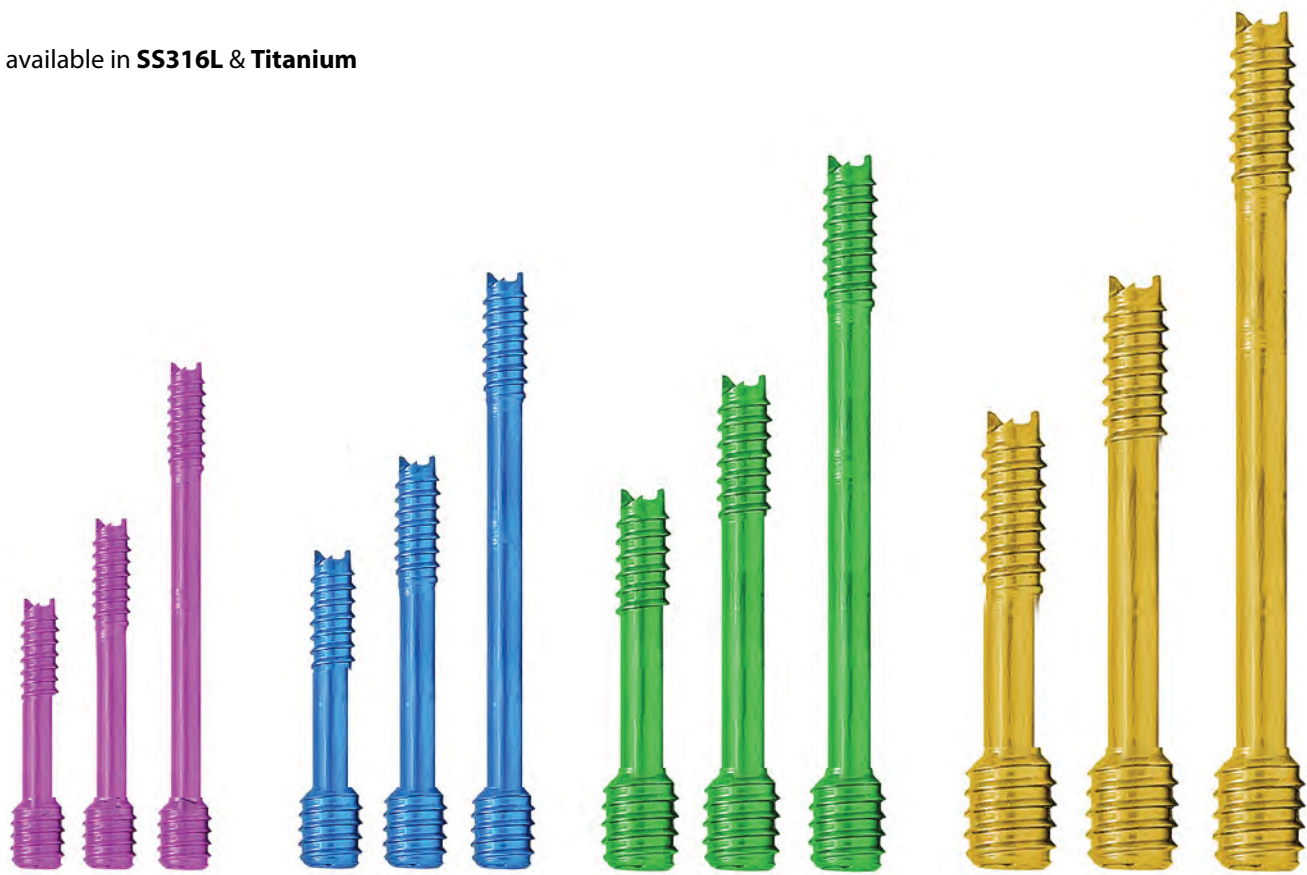

2.5 mm Herbert Screws Cannulated

Length (mm): 8 mm - 30 mm

3 mm Herbert Screws Cannulated

Length (mm): 8 mm - 40 mm

3.5 mm Herbert Screws Cannulated

Length (mm): 10 mm - 60 mm

4 mm Herbert Screws Cannulated

Length (mm): 10 mm - 80 mm

4.5 mm Herbert Screws Cannulated

Length (mm): 10 mm - 100 mm

available in **SS316L & Titanium**

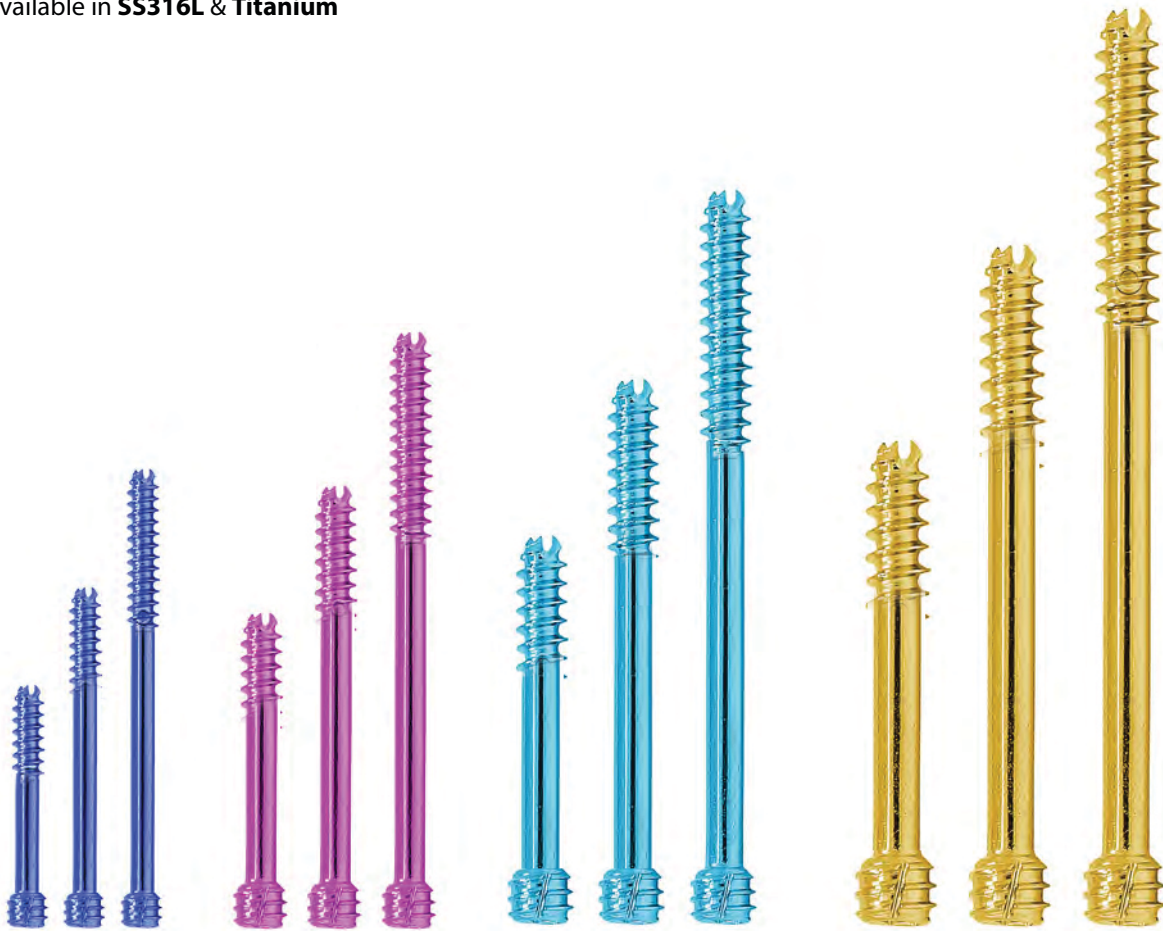

7 mm Interference Screw

8 mm Interference Screw

9 mm Interference Screw

10 mm Interference Screw

11 mm Interference Screw

available in **SS316L & Titanium & PEEK**

Dia (mm)	Length (mm)
6	20
6	25
6	30
7	20
7	25
7	30
8	20
8	25
8	30
9	25
9	30
9	35
10	30
10	35
11	30
11	35



3.5 mm Malleolar Screws

Length (mm): 15 mm - 100 mm

4.5 mm Malleolar Screws

Length (mm): 15 mm - 100 mm

available in **SS316L & Titanium**



DHS-DCS Screws



Sizes, Length (mm)

50, 55, 60, 65, 70, 75, 80, 85, 90, 95, 100, 105, 110, 115, 120, 125, 130, 135, 140, 145 and 150 mm

available in **SS316L & Titanium**

PFNA Blades



Length (mm)

70 / 75 / 80 / 85 / 90 / 95 / 100 / 105 / 110 / 115 / 120
125 / 130 / 135 / 140 / 145 / 150

available in **SS316L & Titanium**

PFNA2 Blades



Length (mm)

70 / 75 / 80 / 85 / 90 / 95 / 100 / 105 / 110 / 115 / 120
125 / 130 / 135 / 140 / 145 / 150

available in **SS316L & Titanium**

8 mm Proximal Cannulated Bolt



Length (mm)

70 / 75 / 80 / 85 / 90 / 95 / 100 / 105 / 110 / 115 / 120
125 / 130 / 135 / 140 / 145 / 150

available in

6.4 mm Proximal Cannulated Bolt



Length (mm)

SS316L & Titanium

50 / 55 / 60 / 65 / 70 / 75 / 80 / 85 / 90 / 95 / 100 / 105 / 110
115 / 120 / 125 / 130 / 135 / 140 / 145 / 150

available in **SS316L & Titanium**

4.9 mm Locking Bolts



Length (mm)

22 / 24 / 26 / 28 / 30 / 32 / 34 / 36 / 38 / 40 / 42 / 44 / 46 / 48 / 50 / 52
54 / 56 / 58 / 60 / 65 / 75 / 80 / 85 / 90 / 95 / 100 / 105 / 110 / 115 / 120

available in **SS316L & Titanium**

3.9 mm Locking Bolt



Length (mm)

22 / 24 / 26 / 28 / 30 / 32 / 34 / 36 / 38 / 40 / 42 / 44 / 46 / 48 / 50 / 52
54 / 56 / 58 / 60 / 65 / 75 / 80 / 85 / 90 / 95 / 100

available in **SS316L & Titanium**

3.4 mm Locking Bolt



Length (mm)

22 / 24 / 26 / 28 / 30 / 32 / 34 / 36 / 38 / 40 / 42 / 44 / 46 / 48 / 50 / 52
54 / 56 / 58 / 60 / 65 / 75 / 80 / 85 / 90 / 95 / 100

available in **SS316L & Titanium**

Chapter - 8 (Page 8.1 - 8.4)

PINS-STAPLES-WIRES

8.1 Steinman Pins



Length (mm)	SS (codes)					
	Dia					
	3 mm	3.5 mm	4 mm	4.5 mm	5 mm	6 mm
150	801001S	801005S	801009S	801013S	801017S	801021S
175	801002S	801006S	801010S	801014S	801018S	801022S
200	801003S	801007S	801011S	801015S	801019S	801023S
225	801004S	801008S	801012S	801016S	801020S	801024S

8.2 Steinman Pins-Centrally Threaded



Dia (mm)	Length (mm)	SS (codes)
4.0	225	802001S
4.5	225	802002S
5.0	225	802003S
6.0	225	802004S

8.3 Austin Moore Pin, Dia 3.0mm with 2 Nuts



Length (mm)	SS (codes)
50	803001S
55	803002S
60	803003S
65	803004S
70	803005S
75	803006S
80	803007S
85	803008S
90	803009S
95	803010S
100	803011S
105	803012S
110	803013S
115	803014S
120	803015S
125	803016S
130	803017S
135	803018S
140	803019S
145	803020S
150	803021S

8.4 Knowles Pin



Dia (mm)	Length (mm)	SS (codes)
3	65	804001S
3	70	804002S
3	75	804003S
3	80	804004S
3	85	804005S
3	90	804006S
3	95	804007S
3	100	804008S
4	65	804009S
4	70	804010S
4	75	804011S
4	80	804012S
4	85	804013S
4	90	804014S
4	95	804015S
4	100	804016S

8.5 Epiphyseal Staple

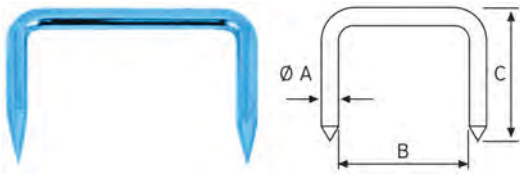

Dia A	Length B	Length C	SS (codes)	Ti (codes)
1.5mm	16mm	19mm	805001S	805001T
1.5mm	22mm	19mm	805002S	805002T
1.5mm	26mm	19mm	805003S	805003T
2.0mm	16mm	19mm	805004S	805004T
2.0mm	22mm	19mm	805005S	805005T
2.0mm	26mm	19mm	805006S	805006T
2.5mm	16mm	19mm	805007S	805007T
2.5mm	22mm	19mm	805008S	805008T
2.5mm	26mm	19mm	805009S	805009T

8.6 Coventry Staple

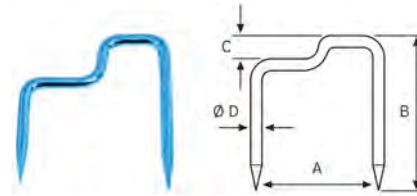

Length A	Length B	Length C	Dia D	SS (codes)	Ti (codes)
25mm	33mm	5mm	2.5mm	806001S	806001T
25mm	33mm	10mm	2.5mm	806002S	806002T
25mm	33mm	15mm	2.5mm	806003S	806003T

8.7 Throny Staple

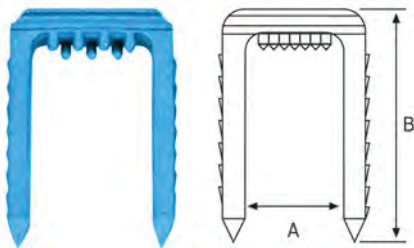

Length A	Length B	Ti (codes)
6.5mm	25mm	807001T
8mm	25mm	807002T
11.5mm	25mm	807003T
15mm	25mm	807004T

8.8 Offset Staple

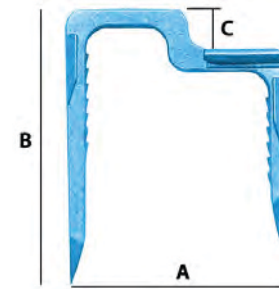

Length A	Length B	Length C	Ti (codes)
24mm	36mm	5mm	808001T
24mm	40mm	10mm	808002T
24mm	44mm	14mm	808003T

8.9 Straight Staple

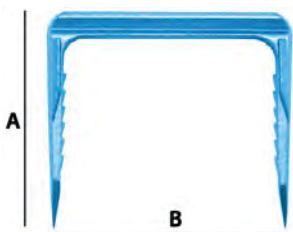

Length A	Length B	Titanium
25mm	20mm	809001T
25mm	26mm	809002T
25mm	36mm	809003T

8.10 Tripods Staples

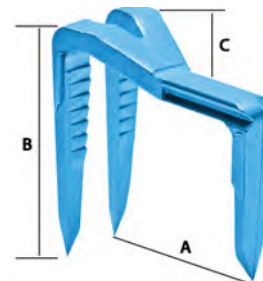

Length A	Length B	Length C	Ti (codes)
26mm	34mm	5mm	810001T

8.11 Suture Wire

Size (mm)	SS (codes)
16 SWG (1.60mm)	811001S
17 SWG (1.50mm)	811002S
18 SWG (1.25mm)	811003S
19 SWG (1.00mm)	811004S
20 SWG (0.90mm)	811005S
21 SWG (0.80mm)	811006S
22 SWG (0.70mm)	811007S
23 SWG (0.60mm)	811008S
24 SWG (0.55mm)	811009S
26 SWG (0.45mm)	811010S
28 SWG (0.35mm)	811011S
30 SWG (0.30mm)	811012S



8.12 Cerclage Wire With Loop



Length (mm)	Size (mm)	SS (codes)
280	21 SWG (0.80mm)	812001S
280	20 SWG (0.90mm)	812002S
280	19 SWG (1.00mm)	812003S
280	18 SWG (1.25mm)	812004S
280	17 SWG (1.50mm)	812005S

8.13 Drummer Wire



Size	SS (codes)
18 SWG (1.25mm)	813001S
19 SWG (1.00mm)	813002S
20 SWG (0.90mm)	813003S

8.14 Kirschner Wire Double Trocar Points



Dia (mm)	SS (codes)					
	Length (mm)					
	70	100	150	225	250	300
0.8	814001S	814015S	814029S	814043S	814057S	814071S
0.9	814002S	814016S	814030S	814044S	814058S	814072S
1.0	814003S	814017S	814031S	814045S	814059S	814073S
1.1	814004S	814018S	8140321S	814046S	814060S	814074S
1.2	814005S	814019S	814033S	814047S	814061S	814075S
1.4	814006S	814020S	814034S	814048S	814062S	814076S
1.5	814007S	814021S	814035S	814049S	814063S	814077S
1.6	814008S	814022S	814036S	814050S	814064S	814078S
1.8	814009S	814023S	814037S	814051S	814065S	814079S
2.0	814010S	814024S	814038S	814052S	814066S	814080S
2.2	814011S	814025S	814039S	814053S	814067S	814081S
2.3	814012S	814026S	814040S	814054S	814068S	814082S
2.5	814013S	814027S	814041S	814055S	814069S	814083S
3.0	814014S	814028S	814042S	814056S	814070S	814084S

8.15 Kirschner Wire Fully Threaded Double Trocar Points



Dia (mm)	Length (mm)	SS (codes)
1.5	225	815001S
2.0	225	815002S
2.5	225	815003S
1.5	150	815004S
2.0	150	815005S
2.5	150	815006S

NOTES

Chapter - 9 (Page 9.1 - 9.4)

DHS-DCS AND ANGLED BLADE PLATE

9.1 DHS Plate (Dynamic Hip Screw Plate)



38 mm Barrel Angle										
Holes	SS (codes)					TI (codes)				
	130°	135°	140°	145°	150°	130°	135°	140°	145°	150°
2	901001S	901016S	901031S	901046S	901061S	901001T	901016T	901031T	901046T	901061T
3	901002S	901017S	901032S	901047S	901062S	901002T	901017T	901032T	901047T	901062T
4	901003S	901018S	901033S	901048S	901063S	901003T	901018T	901033T	901048T	901063T
5	901004S	901019S	901034S	901049S	901064S	901004T	901019T	901034T	901049T	901064T
6	901005S	901020S	901035S	901050S	901065S	901005T	901020T	901035T	901050T	901065T
7	901006S	901021S	901036S	901051S	901066S	901006T	901021T	901036T	901051T	901066T
8	901007S	901022S	901037S	901052S	901067S	901007T	901022T	901037T	901052T	901067T
9	901008S	901023S	901038S	901053S	901068S	901008T	901023T	901038T	901053T	901068T
10	901009S	901024S	901039S	901054S	901069S	901009T	901024T	901039T	901054T	901069T
12	901010S	901025S	901040S	901055S	901070S	901010T	901025T	901040T	901055T	901070T
14	901011S	901026S	901041S	901056S	901071S	901011T	901026T	901041T	901056T	901071T
16	901012S	901027S	901042S	901057S	901072S	901012T	901027T	901042T	901057T	901072T
18	901013S	901028S	901043S	901058S	901073S	901013T	901028T	901043T	901058T	901073T
20	901014S	901029S	901044S	901059S	901074S	901014T	901029T	901044T	901059T	901074T
22	901015S	901030S	901045S	901060S	901075S	901015T	901030T	901045T	901060T	901075T

25 mm Barrel Angle										
Holes	SS (codes)					TI (codes)				
	130°	135°	140°	145°	150°	130°	135°	140°	145°	150°
2	901076S	901087S	901098S	901109S	901120S	901076T	901087T	901098T	901109T	901120T
3	901077S	901088S	901099S	901110S	901121S	901077T	901088T	901099T	901110T	901121T
4	901078S	901089S	901100S	901111S	901122S	901078T	901089T	901100T	901111T	901122T
5	901079S	901090S	901101S	901112S	901123S	901079T	901090T	901101T	901112T	901123T
6	901080S	901092S	901102S	901113S	901124S	901080T	901092T	901102T	901113T	901124T
7	901081S	901092S	901103S	901114S	901125S	901081T	901092T	901103T	901114T	901125T
8	901082S	901093S	901104S	901115S	901126S	901082T	901093T	901104T	901115T	901126T
9	901083S	901094S	901105S	901116S	901127S	901083T	901094T	901105T	901116T	901127T
10	901084S	901095S	901106S	901117S	901128S	901084T	901095T	901106T	901117T	901128T
12	901085S	901096S	901107S	901118S	901129S	901085T	901096T	901107T	901118T	901129T
14	901086S	901097S	901108S	901119S	901130S	901086T	901097T	901108T	901119T	901130T

9.2 DCS Plate (Dynamic Condylar Screw Plate) 95 Degree



Holes	SS (codes)	TI (codes)
6	902001S	902001T
7	902002S	902002T
8	902003S	902003T
9	902004S	902004T
10	902005S	902005T
12	902006S	902006T
14	902007S	902007T
16	902008S	902008T
18	902009S	902009T
20	902010S	902010T
22	902011S	902011T

9.3 Condylar Plate 95 Degree



Holes	Blade Length							
	SS (codes)				TI (codes)			
	50mm	60mm	70mm	80mm	50mm	60mm	70mm	80mm
5	903001S	903012S	903023S	903034S	903001T	903012T	903023T	903034T
6	903002S	903013S	903024S	903035S	903002T	903013T	903024T	903035T
7	903003S	903014S	903025S	903036S	903003T	903014T	903025T	903036T
8	903004S	903015S	903026S	903037S	903004T	903015T	903026T	903037T
9	903005S	903016S	903027S	903038S	903005T	903016T	903027T	903038T
10	903006S	903017S	903028S	903039S	903006T	903017T	903028T	903039T
11	903007S	903018S	903029S	903040S	903007T	903018T	903029T	903040T
12	903008S	903019S	903030S	903041S	903008T	903019T	903030T	903041T
14	903009S	903020S	903031S	903042S	903009T	903020T	903031T	903042T
16	903010S	903021S	903032S	903043S	903010T	903021T	903032T	903043T
18	903011S	903022S	903033S	903044S	903011T	903022T	903033T	903044T

9.4 Angled Blade Plates 130 Degree



Holes	Blade Length									
	SS (codes)					TI (codes)				
	60mm	70mm	80mm	90mm	100mm	60mm	70mm	80mm	90mm	100mm
4	904001S	904007S	904013S	904019S	904025S	904001S	904007S	904013S	904019S	904025T
5	904002S	904008S	904014S	904020S	904026S	904002S	904008S	904014S	904020S	904026T
6	904003S	904009S	904015S	904021S	904027S	904003S	904009S	904015S	904021S	904027T
8	904004S	904010S	904016S	904022S	904028S	904004S	904010S	904016S	904022S	904028T
10	904005S	904011S	904017S	904023S	904029S	904005S	904011S	904017S	904023S	904029T
12	904006S	904012S	904018S	904024S	904030S	904006S	904012S	904018S	904024S	904030T

9.5 Angled blade plates for intertrochanteric femoral osteotomies



Blade Length (mm)	Angle	SS (codes)	TI (codes)
60	110°	905001S	905001T
75	110°	905002S	905002T
85	110°	905003S	905003T
60	120°	905004S	905004T
65	120°	905005S	905005T
70	120°	905006S	905006T
75	120°	905007S	905007T
80	120°	905008S	905008T
85	120°	905009S	905009T
65	130°	905010S	905010T
70	130°	905011S	905011T
75	130°	905012S	905012T
80	130°	905013S	905013T
85	130°	905014S	905014T
90	130°	905015S	905015T
95	130°	905016S	905016T
100	130°	905017S	905017T

Chapter - 10 (Page 10.1 - 10.9)

INTERLOCKING NAILS

PFNA2, Nail

available in



PFNA2, Length 180 mm

SS316L & Titanium



PFNA2, Length 200 mm
PFNA2, Length 240 mm



PFNA2 Long, Length 260 - 420 mm
LEFT & RIGHT

PFNA2, Blades



4.9 mm Locking Bolt

PFNA2, 180/200/240 mm Sizes

Distal Dia (mm)	Angle	Length (mm)
9	130°	180
10	130°	180
11	130°	180
12	130°	180
9	130°	200
10	130°	200
11	130°	200
12	130°	200
9	130°	240
10	130°	240
11	130°	240
12	130°	240

PFNA2, Long Nails Sizes

Dia (mm)	Angle	Length (mm)
9	130°	260
9	130°	280
9	130°	300
9	130°	320
9	130°	340
10	130°	260
10	130°	280
10	130°	300
10	130°	320
10	130°	340
10	130°	380
10	130°	420

PFNA2 End Cap

Extension (mm)
0
5
10
15



PFNA, Nail

available in **SS316L & Titanium**



PFNA, Length 180 mm



PFNA, Length 200 mm



PFNA, Length 240 mm



Dia 9 / 10 mm PFNA Long
Length 300 - 420 mm, Left & Right



Dia 12 / 14 mm PFNA Long
Length 300 - 420 mm, Left & Right



PFNA2, Blades

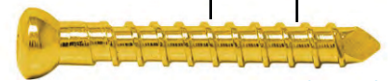

4.9 mm Locking Bolt

PFNA, Long Nails Sizes

PFNA, 180/200/240 mm Sizes

Distal Dia (mm)	Angle	Length (mm)
9	130°	180
10	130°	180
11	130°	180
12	130°	180
9	130°	200
10	130°	200
11	130°	200
12	130°	200
9	130°	240
10	130°	240
11	130°	240
12	130°	240

Dia (mm)	Angle	Length (mm)
9	130°	300
9	130°	320
9	130°	340
9	130°	360
9	130°	380
9	130°	400
9	130°	420
10	130°	300
10	130°	320
10	130°	340
10	130°	360
10	130°	380
10	130°	400
10	130°	420
12	130°	300
12	130°	320
12	130°	340
12	130°	360
12	130°	380
12	130°	400
12	130°	420
14	130°	300
14	130°	320
14	130°	340
14	130°	360
14	130°	380
14	130°	400
14	130°	420

PFNA End Cap

Extension (mm)
0
5
10
15



130°/135° Proximal Femoral Nail (PFN)

available in **SS316L & Titanium**

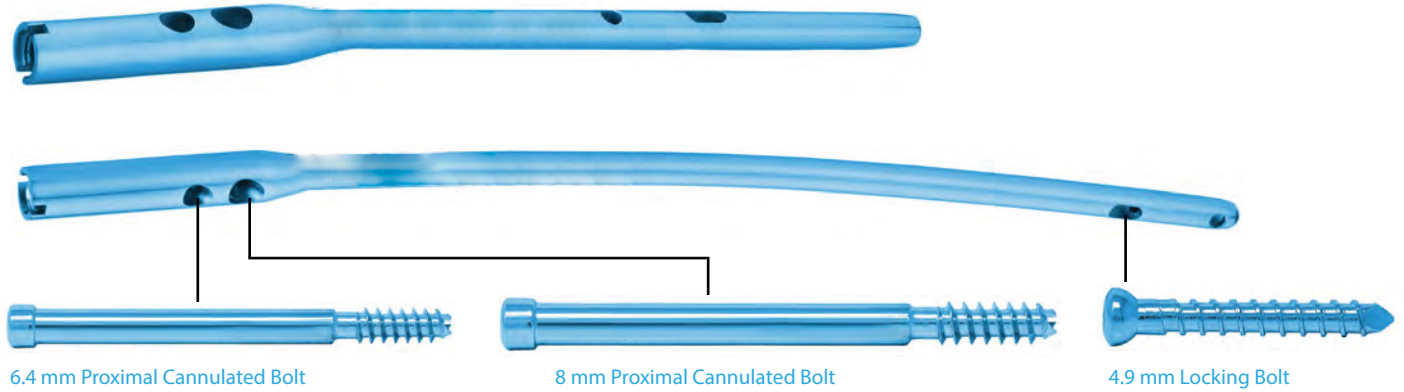

130°/135° Proximal Femoral Nail (PFN) Short

130°/135° Proximal Femoral Nail (PFN), Long

available in **LeftRight**

Dia (mm)	Angle	Length (mm)
9	130 / 135	180
9	130 / 135	200
9	130 / 135	220
9	130 / 135	240
10	130 / 135	180
10	130 / 135	200
10	130 / 135	220
10	130 / 135	240
11	130 / 135	180
11	130 / 135	200
11	130 / 135	220
11	130 / 135	240
12	130 / 135	180
12	130 / 135	200
12	130 / 135	220
12	130 / 135	240

Dia (mm)	Angle	Length (mm)
9	130 / 135	320
9	130 / 135	340
9	130 / 135	360
9	130 / 135	380
9	130 / 135	400
9	130 / 135	420
10	130 / 135	320
10	130 / 135	340
10	130 / 135	360
10	130 / 135	380
10	130 / 135	400
10	130 / 135	420
11	130 / 135	320
11	130 / 135	340
11	130 / 135	360
11	130 / 135	380
11	130 / 135	400
11	130 / 135	420
12	130 / 135	320
12	130 / 135	340
12	130 / 135	360
12	130 / 135	380
12	130 / 135	400
12	130 / 135	420

PFN End Cap



Expert Tibia Nail

available in **SS316L & Titanium**



4.9 mm Locking Bolt

3.9 mm Locking Bolt

Expert Tibia Nail Sizes

Dia (mm)	Length (mm)
8 / 9 / 10 / 11 / 12 / 13	255
8 / 9 / 10 / 11 / 12 / 13	270
8 / 9 / 10 / 11 / 12 / 13	285
8 / 9 / 10 / 11 / 12 / 13	300
8 / 9 / 10 / 11 / 12 / 13	315
8 / 9 / 10 / 11 / 12 / 13	330
8 / 9 / 10 / 11 / 12 / 13	345
8 / 9 / 10 / 11 / 12 / 13	360
8 / 9 / 10 / 11 / 12 / 13	375
8 / 9 / 10 / 11 / 12 / 13	390
8 / 9 / 10 / 11 / 12 / 13	405
8 / 9 / 10 / 11 / 12 / 13	420
8 / 9 / 10 / 11 / 12 / 13	435
8 / 9 / 10 / 11 / 12 / 13	450
8 / 9 / 10 / 11 / 12 / 13	465

Expert Tibia Nail End Cap

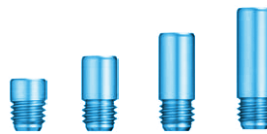

Tibia Nail

available in

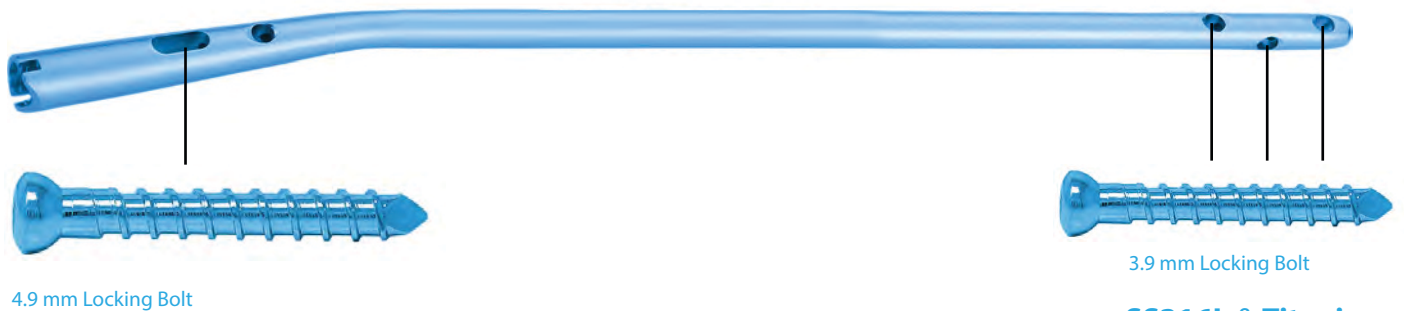

SS316L & Titanium

Tibial Nail Sizes

Dia (mm)	Length (mm)
8 / 9 / 10 / 11 / 12 / 13 / 14	240
8 / 9 / 10 / 11 / 12 / 13 / 14	255
8 / 9 / 10 / 11 / 12 / 13 / 14	270
8 / 9 / 10 / 11 / 12 / 13 / 14	285
8 / 9 / 10 / 11 / 12 / 13 / 14	300
8 / 9 / 10 / 11 / 12 / 13 / 14	315
8 / 9 / 10 / 11 / 12 / 13 / 14	330
8 / 9 / 10 / 11 / 12 / 13 / 14	345
8 / 9 / 10 / 11 / 12 / 13 / 14	360
8 / 9 / 10 / 11 / 12 / 13 / 14	375
8 / 9 / 10 / 11 / 12 / 13 / 14	390
8 / 9 / 10 / 11 / 12 / 13 / 14	405
8 / 9 / 10 / 11 / 12 / 13 / 14	420

10.19 Tibia Nail End Cap



Femoral Nail

available in



SS316L & Titanium

Tibial Nail Sizes

Dia (mm)	Length (mm)
8 / 9 / 10 / 11 / 12 / 13 / 14	240
8 / 9 / 10 / 11 / 12 / 13 / 14	255
8 / 9 / 10 / 11 / 12 / 13 / 14	270
8 / 9 / 10 / 11 / 12 / 13 / 14	285
8 / 9 / 10 / 11 / 12 / 13 / 14	300
8 / 9 / 10 / 11 / 12 / 13 / 14	315
8 / 9 / 10 / 11 / 12 / 13 / 14	330
8 / 9 / 10 / 11 / 12 / 13 / 14	345
8 / 9 / 10 / 11 / 12 / 13 / 14	360
8 / 9 / 10 / 11 / 12 / 13 / 14	375
8 / 9 / 10 / 11 / 12 / 13 / 14	390
8 / 9 / 10 / 11 / 12 / 13 / 14	405
8 / 9 / 10 / 11 / 12 / 13 / 14	420

10.19 Tibia Nail End Cap



Humeral Nail

available in

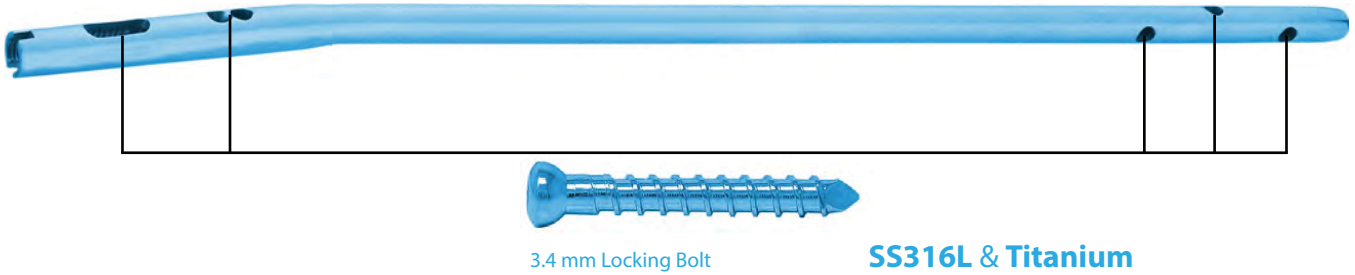

Humeral Nail Sizes

Dia (mm)	Length (mm)
7 / 8 / 9	140
7 / 8 / 9	160
7 / 8 / 9	180
7 / 8 / 9	190
7 / 8 / 9	200
7 / 8 / 9	210
7 / 8 / 9	220
7 / 8 / 9	230
7 / 8 / 9	240
7 / 8 / 9	250
7 / 8 / 9	260
7 / 8 / 9	270
7 / 8 / 9	280
7 / 8 / 9	290
7 / 8 / 9	300
7 / 8 / 9	310
7 / 8 / 9	320

Tibia Nail End Cap



Elastic Nail

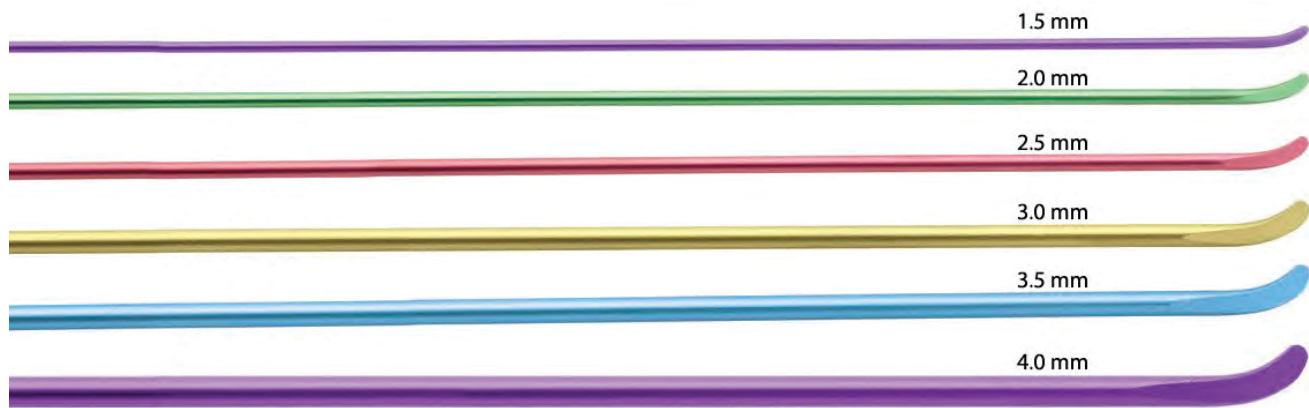

Dia (mm)	Length (mm)
1.5	440
2.0	440
2.5	440
3.0	440
3.5	440
4.0	440

Chapter - 11 (Page 11.1 - 11.5)

HIP PROSTHESIS

11.1 Bipolar Hip Prosthesis, Fenestrated

Head Dia (mm)	SS (codes)	
	Sterile	Non-Sterile
37	1101001S	1101001T
38	1101002S	1101002T
39	1101003S	1101003T
40	1101004S	1101004T
41	1101005S	1101005T
42	1101006S	1101006T
43	1101007S	1101007T
44	1101008S	1101008T
45	1101009S	1101009T
46	1101010S	1101010T
47	1101011S	1101011T
48	1101012S	1101012T
49	1101013S	1101013T
50	1101014S	1101014T
51	1101015S	1101015T
52	1101016S	1101016T
53	1101017S	1101017T
54	1101018S	1101018T
55	1101019S	1101019T



11.2 Bipolar Hip Prosthesis, Non Fenestrated

Head Dia (mm)	SS (codes)	
	Sterile	Non-Sterile
37	1102001S	1102001T
38	1102002S	1102002T
39	1102003S	1102003T
40	1102004S	1102004T
41	1102005S	1102005T
42	1102006S	1102006T
43	1102007S	1102007T
44	1102008S	1102008T
45	1102009S	1102009T
46	1102010S	1102010T
47	1102011S	1102011T
48	1102012S	1102012T
49	1102013S	1102013T
50	1102014S	1102014T
51	1102015S	1102015T
52	1102016S	1102016T
53	1102017S	1102017T
54	1102018S	1102018T
55	1102019S	1102019T



11.3 Austin Moore Hip Prosthesis, Standard Stem

Head Dia (mm)	SS (codes)	
	Sterile	Non-Sterile
37	1103001S	1103001T
38	1103002S	1103002T
39	1103003S	1103003T
40	1103004S	1103004T
41	1103005S	1103005T
42	1103006S	1103006T
43	1103007S	1103007T
44	1103008S	1103008T
45	1103009S	1103009T
46	1103010S	1103010T
47	1103011S	1103011T
48	1103012S	1103012T
49	1103013S	1103013T
50	1103014S	1103014T
51	1103015S	1103015T
52	1103016S	1103016T
53	1103017S	1103017T
54	1103018S	1103018T
55	1103019S	1103019T



11.4 Austin Moore Hip Prosthesis, Narrow Stem

Head Dia (mm)	SS (codes)	
	Sterile	Non-Sterile
37	1104001S	1104001T
38	1104002S	1104002T
39	1104003S	1104003T
40	1104004S	1104004T
41	1104005S	1104005T
42	1104006S	1104006T
43	1104007S	1104007T
44	1104008S	1104008T
45	1104009S	1104009T
46	1104010S	1104010T
47	1104011S	1104011T
48	1104012S	1104012T
49	1104013S	1104013T
50	1104014S	1104014T
51	1104015S	1104015T
52	1104016S	1104016T
53	1104017S	1104017T
54	1104018S	1104018T
55	1104019S	1104019T



11.5 Austin Moore Hip Prosthesis, Broad Stem

Head Dia (mm)	SS (codes)	
	Sterile	Non-Sterile
37	1105001S	1105001T
38	1105002S	1105002T
39	1105003S	1105003T
40	1105004S	1105004T
41	1105005S	1105005T
42	1105006S	1105006T
43	1105007S	1105007T
44	1105008S	1105008T
45	1105009S	1105009T
46	1105010S	1105010T
47	1105011S	1105011T
48	1105012S	1105012T
49	1105013S	1105013T
50	1105014S	1105014T
51	1105015S	1105015T
52	1105016S	1105016T
53	1105017S	1105017T
54	1105018S	1105018T
55	1105019S	1105019T



11.6 Austin Moore Hip Prosthesis, Extra Long Stem

Head Dia (mm)	SS (codes)	
	Sterile	Non-Sterile
37	1106001S	1106001T
38	1106002S	1106002T
39	1106003S	1106003T
40	1106004S	1106004T
41	1106005S	1106005T
42	1106006S	1106006T
43	1106007S	1106007T
44	1106008S	1106008T
45	1106009S	1106009T
46	1106010S	1106010T
47	1106011S	1106011T
48	1106012S	1106012T
49	1106013S	1106013T
50	1106014S	1106014T
51	1106015S	1106015T
52	1106016S	1106016T
53	1106017S	1106017T
54	1106018S	1106018T
55	1106019S	1106019T



11.7 Thompson Hip Prosthesis, Standard Stem

Head Dia (mm)	SS (codes)	
	Sterile	Non-Sterile
37	1107001S	1107001T
38	1107002S	1107002T
39	1107003S	1107003T
40	1107004S	1107004T
41	1107005S	1107005T
42	1107006S	1107006T
43	1107007S	1107007T
44	1107008S	1107008T
45	1107009S	1107009T
46	1107010S	1107010T
47	1107011S	1107011T
48	1107012S	1107012T
49	1107013S	1107013T
50	1107014S	1107014T
51	1107015S	1107015T
52	1107016S	1107016T
53	1107017S	1107017T
54	1107018S	1107018T
55	1107019S	1107019T



11.8 Thompson Hip Prosthesis, Narrow Stem

Head Dia (mm)	SS (codes)	
	Sterile	Non-Sterile
37	1108001S	1108001T
38	1108002S	1108002T
39	1108003S	1108003T
40	1108004S	1108004T
41	1108005S	1108005T
42	1108006S	1108006T
43	1108007S	1108007T
44	1108008S	1108008T
45	1108009S	1108009T
46	1108010S	1108010T
47	1108011S	1108011T
48	1108012S	1108012T
49	1108013S	1108013T
50	1108014S	1108014T
51	1108015S	1108015T
52	1108016S	1108016T
53	1108017S	1108017T
54	1108018S	1108018T
55	1108019S	1108019T



11.9 Thompson Hip Prosthesis, Extra Long Stem

Head Dia (mm)	SS (codes)	
	Sterile	Non-Sterile
37	1109001S	1109001T
38	1109002S	1109002T
39	1109003S	1109003T
40	1109004S	1109004T
41	1109005S	1109005T
42	1109006S	1109006T
43	1109007S	1109007T
44	1109008S	1109008T
45	1109009S	1109009T
46	1109010S	1109010T
47	1109011S	1109011T
48	1109012S	1109012T
49	1109013S	1109013T
50	1109014S	1109014T
51	1109015S	1109015T
52	1109016S	1109016T
53	1109017S	1109017T
54	1109018S	1109018T
55	1109019S	1109019T



Chapter - 12 (Page 12.1 - 12.16)

CRANIOMAXILLOFACIAL

12.01 Y Plate



Size	TI (codes)
1.5 mm	1201001T
2 mm	1201002T
2.5 mm	1201003T
2.8 mm	1201004T
2 mm Locking	1201005T
2.5 mm Locking	1201006T
2.8 mm Locking	1201007T

12.02 Double Y Plate



Size	TI (codes)
1.5 mm	1202001T
2 mm	1202002T
2.5 mm	1202003T
2.8 mm	1202004T
2 mm Locking	1202005T
2.5 mm Locking	1202006T
2.8 mm Locking	1202007T

12.03 X Plate



Size	TI (codes)
1.5 mm	1203001T
2 mm	1203002T
2.5 mm	1203003T
2.8 mm	1203004T
2 mm Locking	1203005T
2.5 mm Locking	1203006T
2.8 mm Locking	1203007T

12.04 H Plate



Size	TI (codes)
1.5 mm	1204001T
2 mm	1204002T
2.5 mm	1204003T
2.8 mm	1204004T
2 mm Locking	1204005T
2.5 mm Locking	1204006T
2.8 mm Locking	1204007T

12.05 Frame Plate Rectangle



Size	TI (codes)
1.5 mm	1205001T
2 mm	1205002T
2.5 mm	1205003T
2.8 mm	1205004T
2 mm Locking	1205005T
2.5 mm Locking	1205006T
2.8 mm Locking	1205007T

12.06 Frame Plate Square



Size	TI (codes)
1.5 mm	1206001T
2 mm	1206002T
2.5 mm	1206003T
2.8 mm	1206004T
2 mm Locking	1206005T
2.5 mm Locking	1206006T
2.8 mm Locking	1206007T

12.07 T Plate

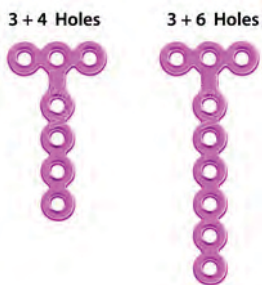

Size	Holes	TI (codes)
1.5 mm	3 + 4	1207001T
2 mm	3 + 4	1207002T
2.5 mm	3 + 4	1207003T
2.8 mm	3 + 4	1207004T
2 mm Locking	3 + 4	1207005T
2.5 mm Locking	3 + 4	1207006T
2.8 mm Locking	3 + 4	1207007T
1.5 mm	3 + 6	1207008T
2 mm	3 + 6	1207009T
2.5 mm	3 + 6	1207010T
2.8 mm	3 + 6	1207011T
2 mm Locking	3 + 6	1207012T
2.5 mm Locking	3 + 6	1207013T
2.8 mm Locking	3 + 6	1207014T

12.08 Strut Plate



Size	Holes	TI (codes)
1.5 mm	2 x 3	1208001T
2 mm	2 x 3	1208002T
2.5 mm	2 x 3	1208003T
2.8 mm	2 x 3	1208004T
2 mm Locking	2 x 3	1208005T
2.5 mm Locking	2 x 3	1208006T
2.8 mm Locking	2 x 3	1208007T
1.5 mm	2 x 4	1208008T
2 mm	2 x 4	1208009T
2.5 mm	2 x 4	1208010T
2.8 mm	2 x 4	1208011T
2 mm Locking	2 x 4	1208012T
2.5 mm Locking	2 x 4	1208013T
2.8 mm Locking	2 x 4	1208014T

12.09 L Plate

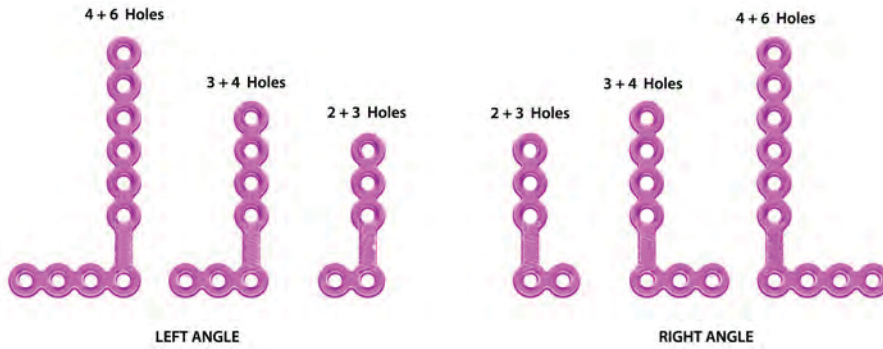

Size	Holes	TI (codes)	
		Left Direction	Right Direction
1.5 mm	2 + 3	1209001LT	1209001RT
2 mm	2 + 3	1209002LT	1209002RT
2.5 mm	2 + 3	1209003LT	1209003RT
2.8 mm	2 + 3	1209004LT	1209004RT
2 mm Locking	2 + 3	1209005LT	1209005RT
2.5 mm Locking	2 + 3	1209006LT	1209006RT
2.8 mm Locking	2 + 3	1209007LT	1209007RT
1.5 mm	3 + 4	1209008LT	1209008RT
2 mm	3 + 4	1209009LT	1209009RT
2.5 mm	3 + 4	1209010LT	1209010RT
2.8 mm	3 + 4	1209011LT	1209011RT
2 mm Locking	3 + 4	1209012LT	1209012RT
2.5 mm Locking	3 + 4	1209013LT	1209013RT
2.8 mm Locking	3 + 4	1209014LT	1209014RT
1.5 mm	4 + 6	1209015LT	1209015RT
2 mm	4 + 6	1209016LT	1209016RT
2.5 mm	4 + 6	1209017LT	1209017RT
2.8 mm	4 + 6	1209018LT	1209018RT
2 mm Locking	4 + 6	1209019LT	1209019RT
2.5 mm Locking	4 + 6	1209020LT	1209020RT
2.8 mm Locking	4 + 6	1209021LT	1209021RT

12.10 L Plate Angle

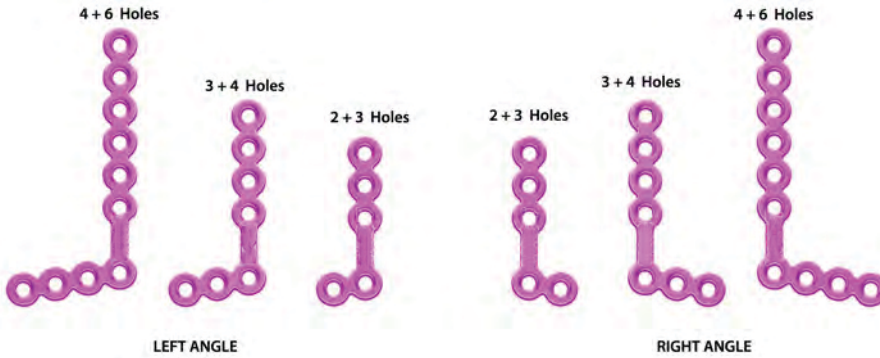

Size	Holes	TI (codes)	
		Left Direction	Right Direction
1.5 mm	2 + 3	1210001LT	1210001RT
2 mm	2 + 3	1210002LT	1210002RT
2.5 mm	2 + 3	1210003LT	1210003RT
2.8 mm	2 + 3	1210004LT	1210004RT
2 mm Locking	2 + 3	1210005LT	1210005RT
2.5 mm Locking	2 + 3	1210006LT	1210006RT
2.8 mm Locking	2 + 3	1210007LT	1210007RT
1.5 mm	3 + 4	1210008LT	1210008RT
2 mm	3 + 4	1210009LT	1210009RT
2.5 mm	3 + 4	1210010LT	1210010RT
2.8 mm	3 + 4	1210011LT	1210011RT
2 mm Locking	3 + 4	1210012LT	1210012RT
2.5 mm Locking	3 + 4	1210013LT	1210013RT
2.8 mm Locking	3 + 4	1210014LT	1210014RT
1.5 mm	4 + 6	1210015LT	1210015RT
2 mm	4 + 6	1210016LT	1210016RT
2.5 mm	4 + 6	1210017LT	1210017RT
2.8 mm	4 + 6	1210018LT	1210018RT
2 mm Locking	4 + 6	1210019LT	1210019RT
2.5 mm Locking	4 + 6	1210020LT	1210020RT
2.8 mm Locking	4 + 6	1210021LT	1210021RT

12.11 Orbital Plate

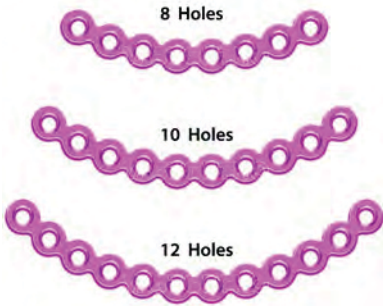

Size	Holes	TI (codes)
1.5 mm	8	1211001T
2 mm	8	1211002T
2.5 mm	8	1211003T
2.8 mm	8	1211004T
2 mm Locking	8	1211005T
2.5 mm Locking	8	1211006T
2.8 mm Locking	8	1211007T
1.5 mm	10	1211008T
2 mm	10	1211013T
2.5 mm	10	1211010T
2.8 mm	10	1211011T
2 mm Locking	10	1211012T
2.5 mm Locking	10	1211013T
2.8 mm Locking	10	1211014T
1.5 mm	12	1211015T
2 mm	12	1211016T
2.5 mm	12	1211017T
2.8 mm	12	1211018T
2 mm Locking	12	1211019T
2.5 mm Locking	12	1211020T
2.8 mm Locking	12	1211021T

12.12 Angle Plate Mandible

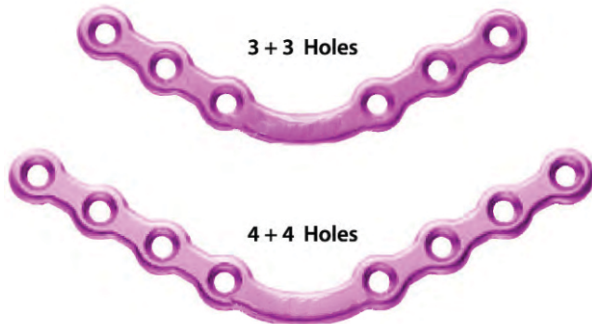

Size	Holes	TI (codes)
1.5 mm	3 + 3	1212001T
2 mm	3 + 3	1212002T
2.5 mm	3 + 3	1212003T
2.8 mm	3 + 3	1212004T
2 mm Locking	3 + 3	1212005T
2.5 mm Locking	3 + 3	1212006T
2.8 mm Locking	3 + 3	1212007T
1.5 mm	4 + 4	1212008T
2 mm	4 + 4	1212009T
2.5 mm	4 + 4	1212012T
2.8 mm	4 + 4	1212011T
2 mm Locking	4 + 4	1212012T
2.5 mm Locking	4 + 4	1212013T
2.8 mm Locking	4 + 4	1212014T

12.13 Crescent Plate Mandible

Size	Holes	TI (codes)
1.5 mm	2 + 2	1213001T
2 mm	2 + 2	1213002T
2.5 mm	2 + 2	1213003T
2.8 mm	2 + 2	1213004T
2 mm Locking	2 + 2	1213005T
2.5 mm Locking	2 + 2	1213006T
2.8 mm Locking	2 + 2	1213007T
1.5 mm	3 + 3	1213008T
2 mm	3 + 3	1213013T
2.5 mm	3 + 3	1213010T
2.8 mm	3 + 3	1213011T
2 mm Locking	3 + 3	1213012T
2.5 mm Locking	3 + 3	1213013T
2.8 mm Locking	3 + 3	1213014T
1.5 mm	5	1213015T
2 mm	5	1213016T
2.5 mm	5	1213017T
2.8 mm	5	1213018T
2 mm Locking	5	1213019T
2.5 mm Locking	5	1213020T
2.8 mm Locking	5	1213021T
1.5 mm	7	1213015T
2 mm	7	1213016T
2.5 mm	7	1213017T
2.8 mm	7	1213018T
2 mm Locking	7	1213019T
2.5 mm Locking	7	1213020T
2.8 mm Locking	7	1213021T

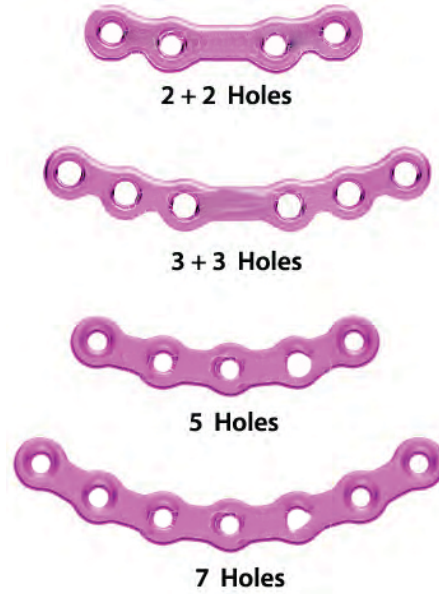

12.14 Straight centre space Plate Mandible



2 + 2 Holes



3 + 3 Holes

Size	Holes	TI (codes)
1.5 mm	2 + 2	1214001T
2 mm	2 + 2	1214002T
2.5 mm	2 + 2	1214003T
2.8 mm	2 + 2	1214004T
2 mm Locking	2 + 2	1214005T
2.5 mm Locking	2 + 2	1214006T
2.8 mm Locking	2 + 2	1214007T
1.5 mm	3 + 3	1214008T
2 mm	3 + 3	1214014T
2.5 mm	3 + 3	1214010T
2.8 mm	3 + 3	1214011T
2 mm Locking	3 + 3	1214012T
2.5 mm Locking	3 + 3	1214014T
2.8 mm Locking	3 + 3	1214014T

12.15 Adaption Plate Mandible

Mandible Adaption Plates are available in following sizes

- 1.5 mm
- 2 mm
- 2.5 mm
- 2.8 mm
- 2 mm Locking
- 2.5 mm Locking
- 2.8 mm Locking

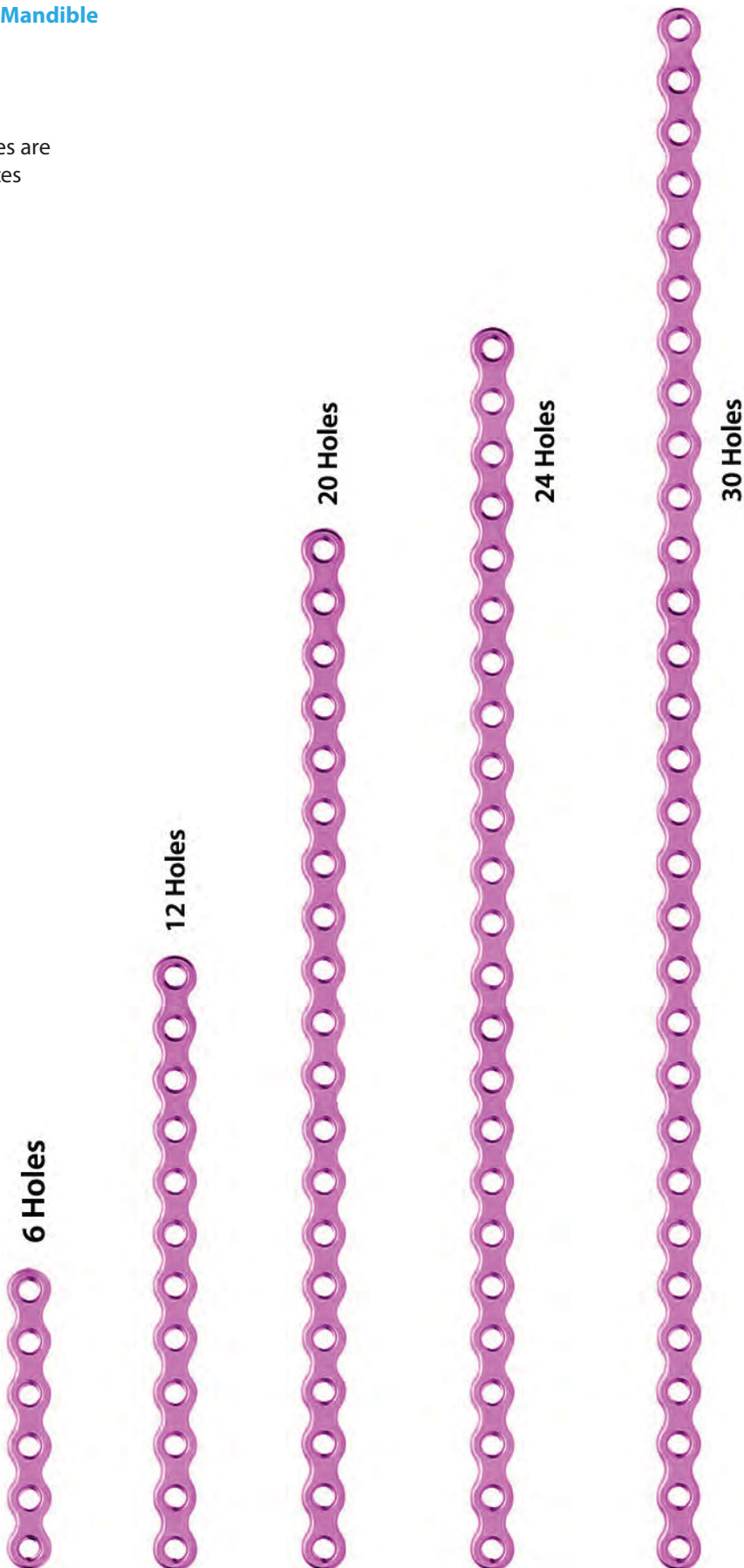

12.15 Adaption Plate Mandible

Size	Holes	TI (codes)
1.5 mm	6	1215001T
2 mm	6	1215002T
2.5 mm	6	1215003T
2.8 mm	6	1215004T
2 mm Locking	6	1215005T
2.5 mm Locking	6	1215006T
2.8 mm Locking	6	1215007T
1.5 mm	12	1215008T
2 mm	12	1215015T
2.5 mm	12	1215010T
2.8 mm	12	1215011T
2 mm Locking	12	1215012T
2.5 mm Locking	12	1215013T
2.8 mm Locking	12	1215014T
1.5 mm	20	1215015T
2 mm	20	1215016T
2.5 mm	20	1215017T
2.8 mm	20	1215018T
2 mm Locking	20	1215019T
2.5 mm Locking	20	1215020T
2.8 mm Locking	20	1215021T
1.5 mm	24	1215015T
2 mm	24	1215016T
2.5 mm	24	1215017T
2.8 mm	24	1215018T
2 mm Locking	24	1215019T
2.5 mm Locking	24	1215020T
2.8 mm Locking	24	1215021T
1.5 mm	30	1215015T
2 mm	30	1215016T
2.5 mm	30	1215017T
2.8 mm	30	1215018T
2 mm Locking	30	1215019T
2.5 mm Locking	30	1215020T
2.8 mm Locking	30	1215021T

12.16 Angle Reconstruction Plate Mandible

Mandible Angle Reconstruction Plate
available in following sizes

- 1.5 mm
- 2 mm
- 2.5 mm
- 2.8 mm
- 2 mm Locking
- 2.5 mm Locking
- 2.8 mm Locking

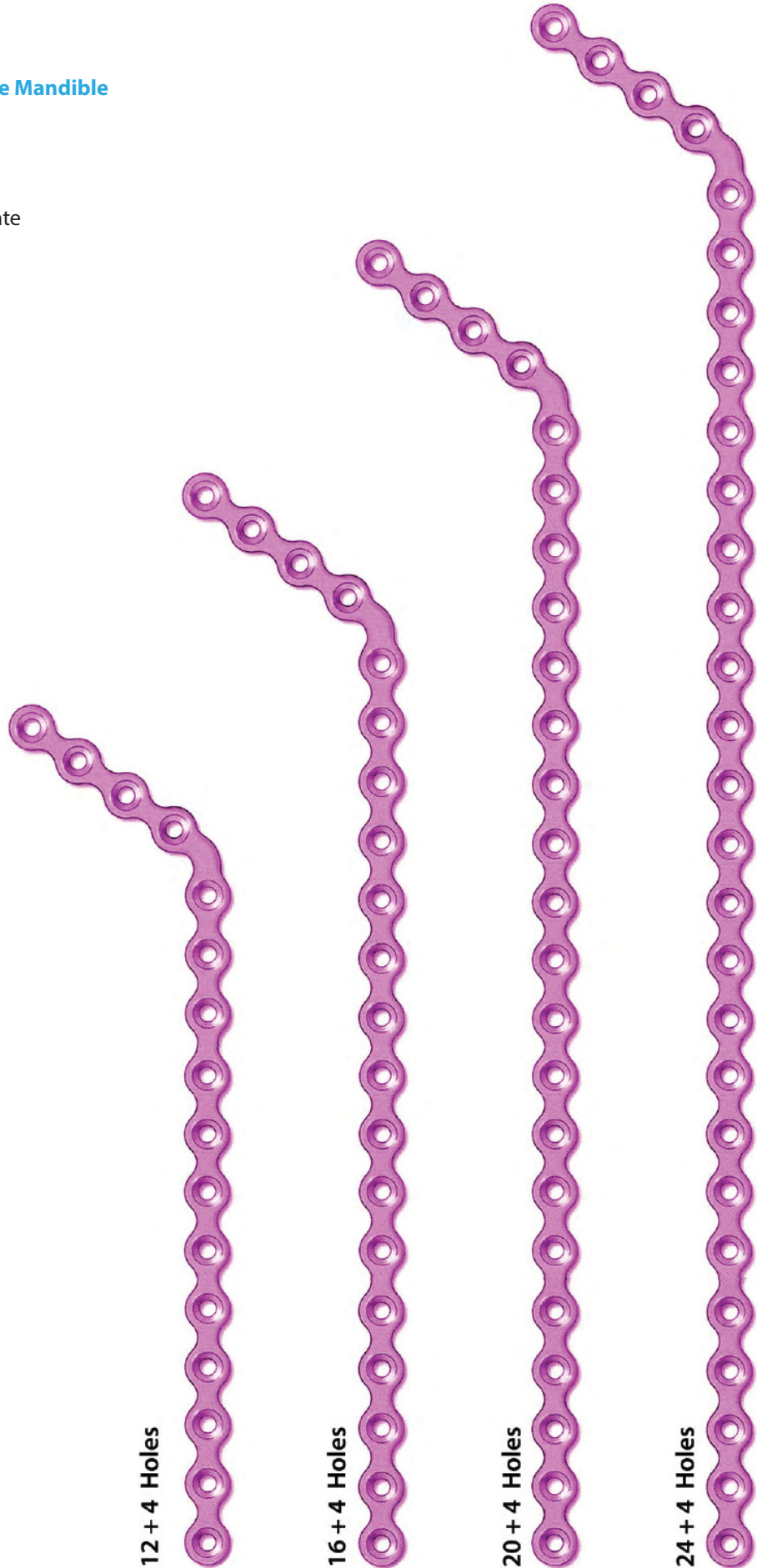

12.16 Angle Reconstruction Plate Mandible

Size	Holes	TI (codes)	
		Left Direction	Right Direction
1.5 mm	12 + 4	1216001LT	1216001RT
2 mm	12 + 4	1216002LT	1216002RT
2.5 mm	12 + 4	1216003LT	1216003RT
2.8 mm	12 + 4	1216004LT	1216004RT
2 mm Locking	12 + 4	1216005LT	1216005RT
2.5 mm Locking	12 + 4	1216006LT	1216006RT
2.8 mm Locking	12 + 4	1216007LT	1216007RT
1.5 mm	16 + 4	1216008LT	1216008RT
2 mm	16 + 4	1216016LT	1216016RT
2.5 mm	16 + 4	1216010LT	1216010RT
2.8 mm	16 + 4	1216011LT	1216011RT
2 mm Locking	16 + 4	1216012LT	1216012RT
2.5 mm Locking	16 + 4	1216013LT	1216013RT
2.8 mm Locking	16 + 4	1216014LT	1216014RT
1.5 mm	20 + 4	1216016LT	1216016RT
2 mm	20 + 4	1216016LT	1216016RT
2.5 mm	20 + 4	1216017LT	1216017RT
2.8 mm	20 + 4	1216018LT	1216018RT
2 mm Locking	20 + 4	1216019LT	1216019RT
2.5 mm Locking	20 + 4	1216020LT	1216020RT
2.8 mm Locking	20 + 4	1216021LT	1216021RT
1.5 mm	24 + 4	1216016LT	1216016RT
2 mm	24 + 4	1216016LT	1216016RT
2.5 mm	24 + 4	1216017LT	1216017RT
2.8 mm	24 + 4	1216018LT	1216018RT
2 mm Locking	24 + 4	1216019LT	1216019RT
2.5 mm Locking	24 + 4	1216020LT	1216020RT
2.8 mm Locking	24 + 4	1216021LT	1216021RT

12.17 Double Angle Reconstruction Plate Mandible

Mandible Double Angle Reconstruction Plate available in following sizes

- 1.5 mm
- 2 mm
- 2.5 mm
- 2.8 mm
- 2 mm Locking
- 2.5 mm Locking
- 2.8 mm Locking

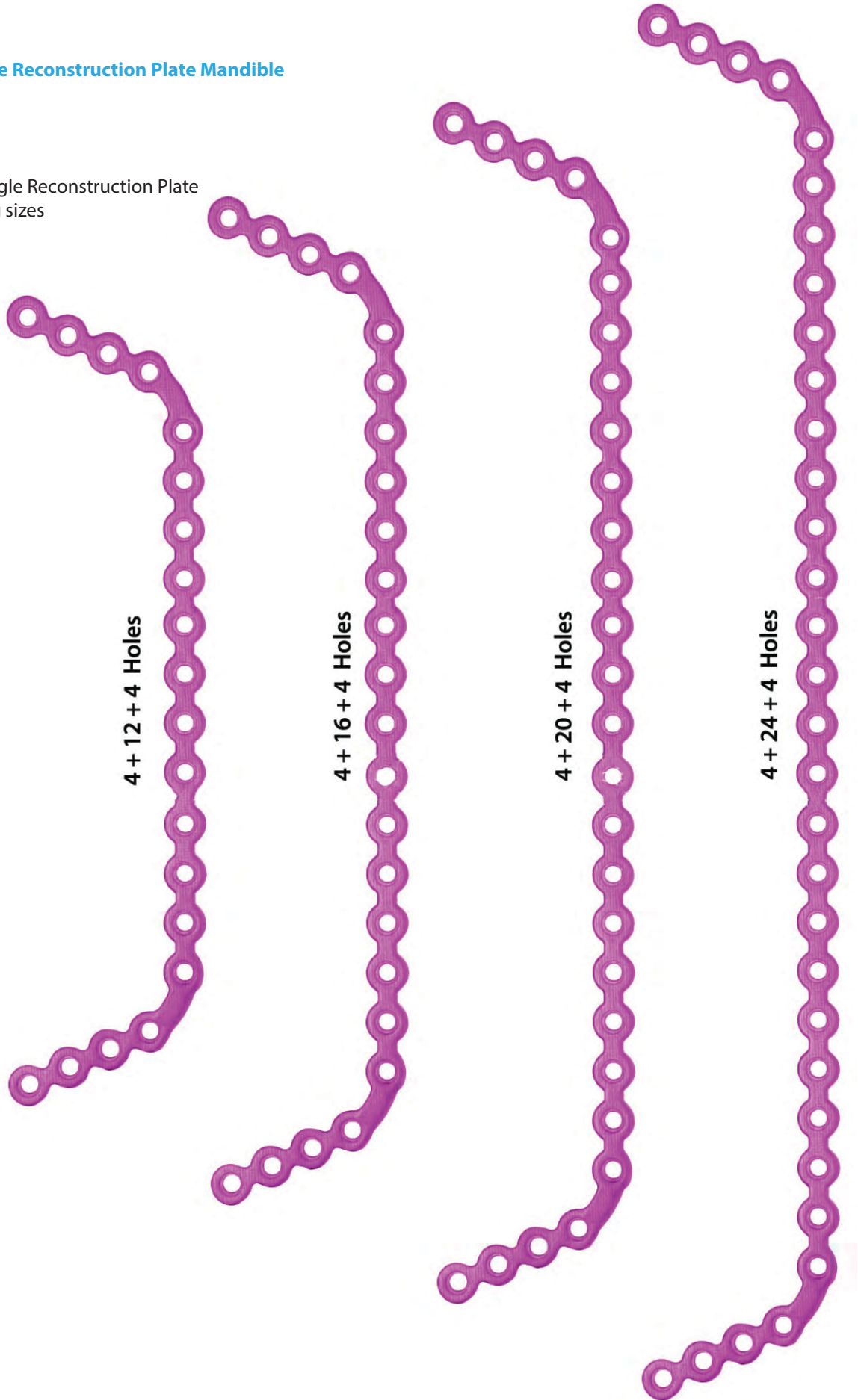

12.17 Double Angle Reconstruction Plate Mandible

Size	Holes	TI (codes)
1.5 mm	4 + 12 + 4	1217001T
2 mm	4 + 12 + 4	1217002T
2.5 mm	4 + 12 + 4	1217003T
2.8 mm	4 + 12 + 4	1217004T
2 mm Locking	4 + 12 + 4	1217005T
2.5 mm Locking	4 + 12 + 4	1217006T
2.8 mm Locking	4 + 12 + 4	1217007T
1.5 mm	4 + 16 + 4	1217008T
2 mm	4 + 16 + 4	1217017T
2.5 mm	4 + 16 + 4	1217010T
2.8 mm	4 + 16 + 4	1217011T
2 mm Locking	4 + 16 + 4	1217012T
2.5 mm Locking	4 + 16 + 4	1217013T
2.8 mm Locking	4 + 16 + 4	1217014T
1.5 mm	4 + 20 + 4	1217015T
2 mm	4 + 20 + 4	1217016T
2.5 mm	4 + 20 + 4	1217017T
2.8 mm	4 + 20 + 4	1217018T
2 mm Locking	4 + 20 + 4	1217019T
2.5 mm Locking	4 + 20 + 4	1217020T
2.8 mm Locking	4 + 20 + 4	1217021T
1.5 mm	4 + 24 + 4	1217015T
2 mm	4 + 24 + 4	1217016T
2.5 mm	4 + 24 + 4	1217017T
2.8 mm	4 + 24 + 4	1217018T
2 mm Locking	4 + 24 + 4	1217019T
2.5 mm Locking	4 + 24 + 4	1217020T
2.8 mm Locking	4 + 24 + 4	1217021T

12.18 1.5 mm Screw - Cross Head



Length (mm)	TI (codes)
8	1218001T
10	1218002T
12	1218003T
14	1218004T
16	1218005T
18	1218006T
20	1218007T
22	1218008T
24	1218009T
26	1218010T
28	1218011T
30	1218012T

12.19 2 mm Screw - Cross Head



Length (mm)	SS (codes)	TI (codes)
8	1219001S	1219001T
10	1219002S	1219002T
12	1219003S	1219003T
14	1219004S	1219004T
16	1219005S	1219005T
18	1219006S	1219006T
20	1219007S	1219007T
22	1219008S	1219008T
24	1219009S	1219009T
26	1219010S	1219010T
28	1219011S	1219011T
30	1219012S	1219012T

12.20 2 mm Locking Screw - Cross Head



Length (mm)	SS (codes)	TI (codes)
8	1220001S	1220001T
10	1220002S	1220002T
12	1220003S	1220003T
14	1220004S	1220004T
16	1220005S	1220005T
18	1220006S	1220006T
20	1220007S	1220007T
22	1220008S	1220008T
24	1220009S	1220009T
26	1220010S	1220010T
28	1220011S	1220011T
30	1220012S	1220012T

12.21 2.5 mm Screw - Cross Head



Length (mm)	SS (codes)	TI (codes)
8	1221001S	1221001T
10	1221002S	1221002T
12	1221003S	1221003T
14	1221004S	1221004T
16	1221005S	1221005T
18	1221006S	1221006T
20	1221007S	1221007T
22	1221008S	1221008T
24	1221009S	1221009T
26	1221010S	1221010T
28	1221011S	1221011T
30	1221012S	1221012T

12.15



12.22 2.5 mm Locking Screw - Cross Head



Length (mm)	SS (codes)	TI (codes)
8	1222001S	1222001T
10	1222002S	1222002T
12	1222003S	1222003T
14	1222004S	1222004T
16	1222005S	1222005T
18	1222006S	1222006T
20	1222007S	1222007T
22	1222008S	1222008T
24	1222009S	1222009T
26	1222010S	1222010T
28	1222011S	1222011T
30	1222012S	1222012T

12.23 2.8 mm Screw - Cross Head



Length (mm)	SS (codes)	TI (codes)
8	1223001S	1223001T
10	1223002S	1223002T
12	1223003S	1223003T
14	1223004S	1223004T
16	1223005S	1223005T
18	1223006S	1223006T
20	1223007S	1223007T
22	1223008S	1223008T
24	1223009S	1223009T
26	1223010S	1223010T
28	1223011S	1223011T
30	1223012S	1223012T

12.24 2.8 mm Locking Screw - Cross Head

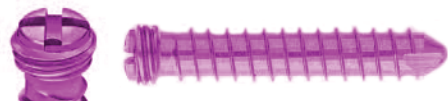

Length (mm)	SS (codes)	TI (codes)
8	1224001S	1224001T
10	1224002S	1224002T
12	1224003S	1224003T
14	1224004S	1224004T
16	1224005S	1224005T
18	1224006S	1224006T
20	1224007S	1224007T
22	1224008S	1224008T
24	1224009S	1224009T
26	1224010S	1224010T
28	1224011S	1224011T
30	1224012S	1224012T

12.25 2.7 mm Emergency Screw

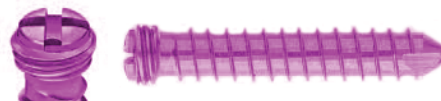

Length (mm)	SS (codes)	TI (codes)
8	1225001S	1225001T
10	1225002S	1225002T
12	1225003S	1225003T
14	1225004S	1225004T
16	1225005S	1225005T
18	1225006S	1225006T
20	1225007S	1225007T
22	1225008S	1225008T
24	1225009S	1225009T
26	1225010S	1225010T
28	1225011S	1225011T
30	1225012S	1225012T

12.16



Chapter - 13 (Page 13.1 - 13.3)

SPINE PRODUCTS

13.1 Anterior Cervical Plate



Holes	Length (mm)	TI (codes)
4	23	1301001T
4	25	1301002T
4	27	1301003T
4	29	1301004T
4	31	1301005T
4	33	1301006T
4	35	1301007T
4	37	1301008T
4	39	1301009T
6	41	1301010T
6	43	1301011T
6	45	1301012T
6	47	1301001T
6	49	1301013T
6	51	1301014T
6	53	1301015T
6	55	1301016T
8	57	1301017T
8	60	1301018T
8	63	1301019T
8	66	1301020T
8	69	1301021T
8	72	1301022T
8	75	1301023T
8	80	1301024T

13.2 3.5 mm Anterior Cervical Screw



Length (mm) 12 / 14 / 16 / 18 / 20
available in

13.2 3.5 mm Anterior Cervical Screw



Length (mm) **Titanium** 18 / 20
available in **Titanium**

13.4 Monoaxial Pedicle Screw



Dia (mm) 4.5 / 5 / 5.5 / 6.5 / 7
 Length (mm) 25 / 30 / 35 / 40 / 45 / 50 / 55 / 60
 available in

13.5 Monoaxial Reduction Pedicle Screw



Dia (mm) 4.5 / 5 / 5.5 / 6.5 / 7
 Length (mm) 25 / 30 / 35 / 40 / 45 / 50 / 55 / 60
 available in **Titanium**

13.6 Polyaxial Pedicle Screws



Dia (mm) 4.5 / 5 / 5.5 / 6.5 / 7
 Length (mm) 25 / 30 / 35 / 40 / 45 / 50 / 55 / 60
 available in **Titanium**

13.7 Polyaxial Reduction Pedicle Screw



Dia (mm) 4.5 / 5 / 5.5 / 6.5 / 7 **Titanium**
 Length (mm) 25 / 30 / 35 / 40 / 45 / 50 / 55 / 60
 available in **Titanium**

13.8 Crosslink Connector / Transverse Connector



Length (mm) 40 / 45 / 50 / 55 / 60 / 65 / 70 / 75 / 80 / 85 / 90 / 95 / 100
 available in **Titanium**

13.9 Crosslink Connector / Transverse Connector



Length (mm) 35 - 42 | 42 - 52 | 52 - 62
 available in **Titanium**

13.10 Laminar Hook



13.11 Pedicle Hook



13.12 Connecting Rod



Dia (mm) 5.5 **Titanium**
 Length (mm) 80 to 400 (20 mm increment)
 available in

13.2

13.13 Cervical Cage | Anterior Cervical Interbody Fusion (ACIF Cage)



Dia (mm) 4 / 5 / 6 / 7 / 8 / 9 / 10
 Length (mm) 13
 Width (mm) 16
 available in **PEEK & Titanium**

13.14 Lumbar Cage | Posterior Lumbar Interbody Fusion (PLIF Cage)



Dia (mm) 8 / 10 / 12 / 14 / 16
 Length (mm) 20 / 24 / 28 / 32
 Width (mm) 10
 available in

13.15 TLIF Cage | Transforaminal Lumbar Interbody Fusion Cage



Dia (mm) 8 / 10 / 12 / 14 / 16
 Length (mm) 24 / 28 / 32
 available in **PEEK & Titanium**

13.16 Spine Mesh



Dia (mm) 10 / 12 / 14 / 16 / 18 / 20
 Length (mm) 20 / 24 / 28 / 32 / 36 / 40
 available in

Chapter - 14 (Page 14.1 - 14.20)

EXTERNAL FIXATORS

14.1 Schanz Screw / Schanz Pin



SS (codes)	Dia (mm)	Thread Length (mm)	Total Length (mm)
1401001S	4	20	60
1401002S	4	20	80
1401003S	4	30	100
1401004S	4	40	125
1401005S	4	40	150
1401006S	4	40	175
1401007S	4.5	20	60
1401008S	4.5	20	80
1401009S	4.5	30	100
1401010S	4.5	40	125
1401011S	4.5	40	150
1401012S	4.5	40	175
1401013S	5.0	30	100
1401014S	5.0	40	125
1401015S	5.0	60	150
1401016S	5.0	60	175
1401017S	5.0	80	200
1401018S	5.0	80	250
1401019S	5.5	30	100
1401020S	5.5	40	125
1401021S	5.5	60	150
1401022S	5.5	60	175
1401023S	5.5	80	200
1401024S	5.5	80	250
1401025S	6	30	100
1401026S	6	40	125
1401027S	6	60	150
1401028S	6	60	175
1401029S	6	80	200
1401030S	6	80	250
1401031S	6.5	80	200
1401032S	6.5	80	225
1401033S	6.5	80	250
1401024S	6.5	90	275
1401035S	6.0	100	300

14.2 Schanz Screw / Schanz Pin Self Tapping



SS (codes)	Dia (mm)	Thread Length (mm)	Total Length (mm)
1402001S	4	20	60
1402002S	4	20	80
1402003S	4	30	100
1402004S	4	40	125
1402005S	4	40	150
1402006S	4	40	175
1402007S	4.5	20	60
1402008S	4.5	20	80
1402009S	4.5	30	100
1402010S	4.5	40	125
1402011S	4.5	40	150
1402012S	4.5	40	175
1402013S	5.0	30	100
1402014S	5.0	40	125
1402015S	5.0	60	150
1402016S	5.0	60	175
1402017S	5.0	80	200
1402018S	5.0	80	250
1402019S	5.5	30	100
1402020S	5.5	40	125
1402021S	5.5	60	150
1402022S	5.5	60	175
1402023S	5.5	80	200
1402024S	5.5	80	250
1402025S	6	30	100
1402026S	6	40	125
1402027S	6	60	150
1402028S	6	60	175
1402029S	6	80	200
1402030S	6	80	250
1402031S	6.5	80	200
1402032S	6.5	80	225
1402033S	6.5	80	250
1402024S	6.5	90	275
1402035S	6.0	100	300

14.3 Tapered Threaded Schanz Screw / Schanz Pin



SS (codes)	Thread Dia (mm)	Thread Length (mm)	Total Length (mm)
1403001S	6 - 5	30	100
1403002S	6 - 5	30	120
1403003S	6 - 5	30	130
1403004S	6 - 5	30	150
1403005S	6 - 5	40	100
1403006S	6 - 5	40	120
1403007S	6 - 5	40	130
1403008S	6 - 5	40	150
1403009S	6 - 5	40	170
1403010S	6 - 5	40	180
1403011S	6 - 5	50	100
1403012S	6 - 5	50	120
1403013S	6 - 5	50	130
1403014S	6 - 5	50	150
1403015S	6 - 5	50	170
1403016S	6 - 5	50	180
1403017S	6 - 5	60	130
1403018S	6 - 5	60	150
1403019S	6 - 5	60	170
1403020S	6 - 5	60	180
1403021S	6 - 5	60	200
1403022S	6 - 5	70	170
1403023S	6 - 5	70	180
1403024S	6 - 5	70	200
1403025S	6 - 5	80	180
1403026S	6 - 5	80	200
1403027S	4.5 - 3.5	20	80
1403028S	4.5 - 3.5	20	100
1403029S	4.5 - 3.5	20	120
1403030S	4.5 - 3.5	30	80
1403031S	4.5 - 3.5	30	100
1403032S	4.5 - 3.5	30	120
1403033S	4.5 - 3.5	40	100
1403034S	4.5 - 3.5	40	110
1403035S	4.5 - 3.5	40	120

14.4 Single Pin Clamp - Superior

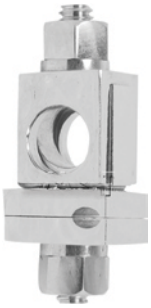

14.5 Double Pin Clamp - Superior

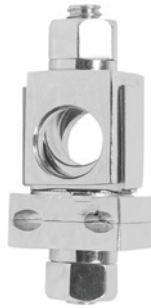

14.6 Open Single Pin Clamp



14.7 Tube to Tube Clamp



14.8 Connecting Clamp



14.9 Self Holding Clamp



14.10 Twin Adjustable Clamp Straight



14.11 Twin Adjustable Clamp Curved



14.12 Transverse Clamp



14.13 Compression Distraction Device



14.14 Connecting Rod Dia 5 mm, Length 200 mm, Stainless Steel



14.15 Connecting Rod Dia 5 mm, Length 200 mm, Carbon Fiber



14.16 Tubular Rod, Dia 11mm, Stainless Steel



Codes	Length
1416001	100mm (4")
1416001	150mm (6")
1416001	200mm (8")
1416001	250mm (10")
1416001	300mm (12")
1416001	350mm (14")
1416001	400mm (16")
1416001	450mm (18")
1416001	500mm (20")

14.17 Tubular Rod, Dia 11mm, Carbon Fiber



Codes	Length
1417001	100 mm (4")
1417001	150 mm (6")
1417001	200 mm (8")
1417001	250 mm (10")
1417001	300 mm (12")
1417001	350 mm (14")
1417001	400 mm (16")
1417001	450 mm (18")
1417001	500 mm (20")

14.18 Triple Trocar Set with Handle



14.19 Sleeve for Cancellous Shanz Pin



14.20 Schanz Pin Introducer

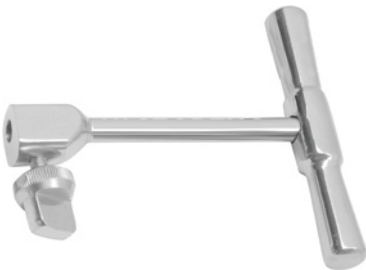

14.21 T Wrench/Spanner 11 mm



14.22 Box Wrench/Spanner 11 mm



14.23 Wrench/Spanner 11 mm



14.24 Wrench/Spanner 11 mm Fiber Handle



14.25 Angulated Wrench 11 mm



14.26 Small Single Pin Clamp



Codes	Size (mm)
1426001	4 x 2.5 mm
1426002	4 x 4 mm

14.27 Small Connecting Clamp



14.28 Small Open Single Pin Clamp



Codes	Size (mm)
1428001	4 x 2.5 mm
1428002	4 x 4 mm

14.29 Connecting Rod Dia 4 mm Carbon Fiber



Codes	Length
1429001	100mm (4")
1429002	150mm (6")
1429003	200mm (8")
1429004	250mm (10")
1429005	300mm (12")
1429009	350mm (14")

14.30 Connecting Rod Dia 4 mm Stainless Steel



Codes	Length
1430001	100mm (4")
1430002	150mm (6")
1430003	200mm (8")
1430004	250mm (10")
1430005	300mm (12")
1430009	350mm (14")

14.7



14.31 Double Sleeve Dia 2.5 mm / 4 mm



14.32 T Wrench/Spanner 8 mm



14.33 Box Wrench/Spanner 8 mm



14.34 Wrench/Spanner 8 mm



14.35 Wrench/Spanner 8 mm Fiber Handle



14.36 Angulated Wrench 8 mm



14.37 Rail



Codes	Length (mm)
1437001	240
1437002	300
1437003	400

14.38 Central Clamp



14.39 End Clamp



14.40 T Clamp



14.41 Ball and Socket Clamp



14.42 T Ball and Socket Clamp



14.43 Swivel Clamp



14.44 Graduated Swivel Clamp



14.45 Dyna Ring Clamp



14.9



14.46 Template for End and Central Clamp



14.47 Template for Swivel Clamp



14.48 Screw Guide



Codes	Length (mm)
1448001	32
1448002	45
1448003	60
1448004	80
1448005	100

14.49 Drill Guide



Codes	Size (mm)
1449001	3.2 X 40
1449002	3.2 X 60
1449003	3.2 X 80
1449004	4.8 X 40
1449005	4.8 X 60
1449006	4.8 X 80
1449007	4.8 X 120

14.50 Sandwich Plate



14.51 Bolt for Sandwich Plate



14.52 CD Unit



Codes	Length (mm)
1452001	40
1452002	80

14.53 Half Pin Introducer

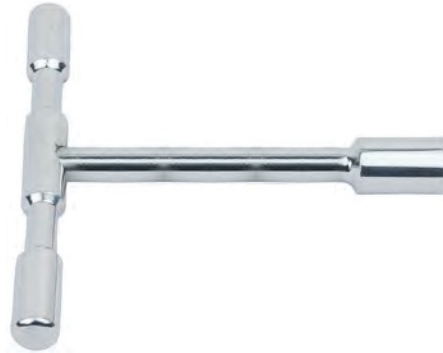

14.54 Allen Key 6mm



14.55 Drill Bit



Codes	Size (mm)
1455001	3.2 x 200
1455002	4.8 x 200

14.56 Full Ring Stainless Steel



Codes	Size (mm)
1456001	100
1456002	120
1456003	140
1456004	160
1456005	180
1456006	200
1456007	220
1456008	240

14.57 Full Ring Carbon Fiber



Codes	Size (mm)
1457001	100
1457002	120
1457003	140
1457004	160
1457005	180
1457006	200
1457007	220
1457008	240

14.58 5/8 Ring Stainless Steel



Codes	Size (mm)
1458001	100
1458002	120
1458003	140
1458004	160
1458005	180
1458006	200
1458007	220
1458008	240

14.59 5/8 Ring Carbon Fiber



Codes	Size (mm)
1459001	100
1459002	120
1459003	140
1459004	160
1459005	180
1459006	200
1459007	220
1459008	240

14.60 Half Ring Stainless Steel



Codes	Size (mm)
1460001	100
1460002	120
1460003	140
1460004	160
1460005	180
1460006	200
1460007	220
1460008	240

14.61 Half Ring Carbon Fiber



Codes	Size (mm)
1461001	100
1461002	120
1461003	140
1461004	160
1461005	180
1461006	200
1461007	220
1461008	240

14.62 3/4 Ring Carbon Fiber



Codes	Size (mm)
1462001	100
1462002	120
1462003	140
1462004	160
1462005	180
1462006	200
1462007	220
1462008	240

14.63 1/4 Ring Carbon Fiber



Codes	Size (mm)
1463001	100
1463002	120
1463003	140
1463004	160
1463005	180
1463006	200
1463007	220
1463008	240

14.13



14.64 Italian Femoral Arch 90 Degree, Stainless Steel



Codes	Size (mm)
1464001	100
1464002	120
1464003	140
1464004	160
1464005	180
1464006	200
1464007	220
1464008	240

14.65 Italian Femoral Arch 90 Degree Carbon Fiber



Codes	Size (mm)
1465001	100
1465002	120
1465003	140
1465004	160
1465005	180
1465006	200
1465007	220
1465008	240

14.66 Italian Femoral Arch 120 Degree, Stainless Steel



Codes	Size (mm)
1466001	100
1466002	120
1466003	140
1466004	160
1466005	180
1466006	200
1466007	220
1466008	240

14.67 Italian Femoral Arch 120 Degree Carbon Fiber



Codes	Size (mm)
1467001	100
1467002	120
1467003	140
1467004	160
1467005	180
1467006	200
1467007	220
1467008	240

14.68 Short Connection Plate Stainless Steel



Codes	Holes
1468001	2
1468002	3
1468003	4
1468004	5
1468005	6
1468006	7
1468007	8
1468008	9
1468009	10

14.69 Connecting Plate Carbon Fiber



Codes	Holes
1469001	2
1469002	3
1469003	4
1469004	5
1469005	6
1469006	7
1469007	8
1469008	9
1469009	10

14.70 Connection Plates with Threaded Ends



Codes	Holes
1470001	5
1470002	7
1470003	9
1470004	11

14.71 Curved Plate



Codes	Holes
1471001	3
1471002	4
1471003	5
1471004	6

14.72 Twisted Plate



Codes	Holes
1472001	2
1472002	3
1472003	4

14.73 Threaded Socket



Codes	Size (mm)
1473001	20
1473002	30
1473003	40
1473004	60

14.15



14.74 Threaded Rods



Codes	Size (mm)
1474001	75
1474002	100
1474003	125
1474004	150
1474005	200
1474006	250
1474007	300
1474008	350
1474009	400
1474010	450

14.75 Threaded Rods Slotted



Codes	Size (mm)
1475001	75
1475002	100
1475003	125
1475004	150

14.76 Telescopic Rod



Codes	Size (mm)
1476001	100
1476002	150
1476003	200
1476004	250
1476005	300

14.77 Graduated Telescopic Rod



Codes	Size (mm)
1477001	100
1477002	150

14.78 Oblique Support



14.16



14.79 Post Male



Codes	Holes
1479001	2
1479002	3
1479003	4

14.80 Post Female



Codes	Holes
1480001	2
1480002	3
1480003	4

14.81 Hinge - Male



14.82 Hinge - Female



14.83 Hinge-90°



14.84 Hinge Joint



14.85 Ilizarov Rotation device



14.86 Pin Blocks



Codes	Holes
1486001	1
1486002	2
1486003	3
1486004	4

14.17



14.87 Ilizarov Wire Bayonet Point



Codes	Size (mm)	Length (mm)
1487001	1.5	400
1487002	1.8	400

14.88 Ilizarov Wire Trocar Point



Codes	Size (mm)	Length (mm)
1488001	1.5	400
1488002	1.8	400

14.89 Olive Wire Bayonet Point



Codes	Size (mm)	Length (mm)
1489001	1.5	400
1489002	1.8	400

14.90 Olive Wire Trocar Point



Codes	Size (mm)	Length (mm)
1490001	1.5	400
1490002	1.8	400

14.91 Multi Pin Fixation Clamp

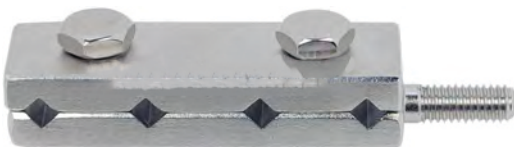

14.92 Wire Fixation Buckle

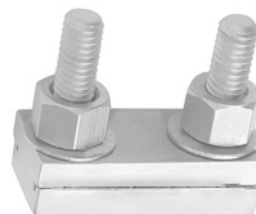

14.93 Wire Fixation Bolt Slotted



14.94 Wire Fixation Bolt Cannulated



14.95 Single Pin Fixation Bolt



14.18



14.96 Conical Washer (Pair)



14.97 Connection Bolt

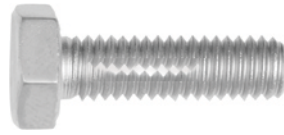

14.98 Nut - 10mm



14.99 Square Nut



14.100 Nylon Insert Nut



14.101 Flat Sided Washer



14.102 Slotted Washer

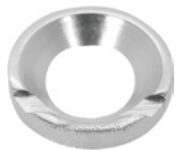

14.103 Spacing Washer



14.104 Washer Hanger

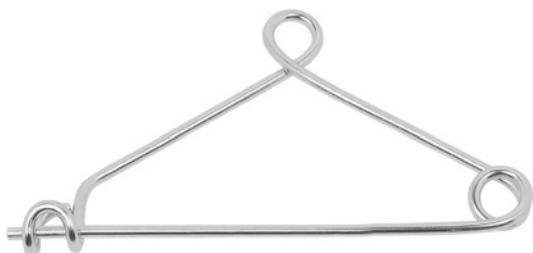

14.19

14.105 Dynamic Wire Tensioners



14.106 Corticotome



Codes	Size (mm)
1449001	5
1449002	7
1449003	10
1449004	15

14.107 Box Wrench/Spanner 10 mm



14.108 Wrench/Spanner 10 mm



14.109 Wrench/Spanner 10 mm Fiber Handle



14.110 Angulated Wrench 10 mm



Chapter - 15 (Page 15.1 - 15.3)

HAND & FOOT

15.01 2 / 2.4 / 2.7 mm Locking Straight Plate



Size	Holes	TI (codes)
2 mm	4	1501001T
2 mm	5	1501002T
2 mm	6	1501003T
2 mm	7	1501004T
2 mm	8	1501005T
2 mm	10	1501006T
2.4 mm	4	1501007T
2.4 mm	5	1501008T
2.4 mm	6	1501009T
2.4 mm	7	1501010T
2.4 mm	8	1501011T
2.4 mm	10	1501012T
2.7 mm	4	1501013T
2.7 mm	5	1501014T
2.7 mm	6	1501015T
2.7 mm	7	1501016T
2.7 mm	8	1501017T
2.7 mm	10	1501018T

15.02 2 / 2.4 / 2.7 mm Locking Straight Adaption Plate



Size	Holes	TI (codes)
2 mm	6	1502001T
2 mm	8	1502002T
2 mm	10	1502003T
2 mm	12	1502004T
2.4 mm	6	1502005T
2.4 mm	8	1502006T
2.4 mm	10	1502007T
2.4 mm	12	1502008T
2.7 mm	6	1502009T
2.7 mm	8	1502010T
2.7 mm	10	1502011T
2.7 mm	12	1502012T

15.03 2 / 2.4 / 2.7 mm Locking T Plate



15.04 2 / 2.4 / 2.7 mm Locking T Adaption Plate



Size	Holes	TI (codes)
2 mm	4	1503001T
2 mm	5	1503002T
2 mm	6	1503003T
2 mm	7	1503004T
2 mm	8	1503005T
2.4 mm	4	1503006T
2.4 mm	5	1503007T
2.4 mm	6	1503008T
2.4 mm	7	1503009T
2.4 mm	8	1503010T
2.7 mm	4	1503011T
2.7 mm	5	1503012T
2.7 mm	6	1503013T
2.7 mm	7	1503014T
2.7 mm	8	1503015T

Size	Holes	TI (codes)
2 mm	4	1504001T
2 mm	5	1504002T
2 mm	6	1504003T
2 mm	7	1504004T
2 mm	8	1504005T
2.4 mm	4	1504006T
2.4 mm	5	1504007T
2.4 mm	6	1504008T
2.4 mm	7	1504009T
2.4 mm	8	1504010T
2.7 mm	4	1504011T
2.7 mm	5	1504012T
2.7 mm	6	1504013T
2.7 mm	7	1504014T
2.7 mm	8	1504015T

15.05 2 / 2.4 / 2.7 mm Locking Y Adaption Plate



Size	Holes	TI (codes)
2 mm	4	1505001T
2 mm	5	1505002T
2 mm	6	1505003T
2 mm	7	1505004T
2 mm	8	1505005T
2.4 mm	4	1505006T
2.4 mm	5	1505007T
2.4 mm	6	1505008T
2.4 mm	7	1505009T
2.4 mm	8	1505010T
2.7 mm	4	1505011T
2.7 mm	5	1505012T
2.7 mm	6	1505013T
2.7 mm	7	1505014T
2.7 mm	8	1505015T

15.06 2 / 2.4 / 2.7 mm Locking Condylar Plate



Size	Holes	TI (codes)
2 mm	4	1506001T
2 mm	5	1506002T
2 mm	6	1506003T
2 mm	7	1506004T
2 mm	8	1506005T
2.4 mm	4	1506006T
2.4 mm	5	1506007T
2.4 mm	6	1506008T
2.4 mm	7	1506009T
2.4 mm	8	1506010T
2.7 mm	4	1506011T
2.7 mm	5	1506012T
2.7 mm	6	1506013T
2.7 mm	7	1506014T
2.7 mm	8	1506015T

15.07 2 / 2.4 / 2.7 mm Locking L Plate



Size	Holes	TI (codes)
2 mm	3 Shaft - 2 Head	1507001T
2 mm	3 Shaft - 2 Head	1507002T
2 mm	4 Shaft - 2 Head	1507003T
2 mm	4 Shaft - 2 Head	1507004T
2.4 mm	3 Shaft - 2 Head	1507006T
2.4 mm	3 Shaft - 2 Head	1507007T
2.4 mm	4 Shaft - 2 Head	1507008T
2.4 mm	4 Shaft - 2 Head	1507009T
2.7 mm	3 Shaft - 2 Head	1507011T
2.7 mm	3 Shaft - 2 Head	1507013T
2.7 mm	4 Shaft - 2 Head	1507014T
2.7 mm	4 Shaft - 2 Head	1507015T

15.08 2 / 2.4 / 2.7 mm Locking L Plate Angle



Size	Holes	TI (codes)
2 mm	3 Shaft - 2 Head	1508001T
2 mm	3 Shaft - 2 Head	1508002T
2 mm	4 Shaft - 2 Head	1508003T
2 mm	4 Shaft - 2 Head	1508004T
2.4 mm	3 Shaft - 2 Head	1508006T
2.4 mm	3 Shaft - 2 Head	1508007T
2.4 mm	4 Shaft - 2 Head	1508008T
2.4 mm	4 Shaft - 2 Head	1508009T
2.7 mm	3 Shaft - 2 Head	1508011T
2.7 mm	3 Shaft - 2 Head	1508013T
2.7 mm	4 Shaft - 2 Head	1508014T
2.7 mm	4 Shaft - 2 Head	1508015T

**Edition
2022**

Orthopedic Implants
CATALOG



Call: +92 344 3961923

WhatsApp: +92 344 3961923

Email: info@alzahrawisurgical.com

Email: alzahrawi.surgical@gmail.com

Website: www.alzahrawisurgical.com